

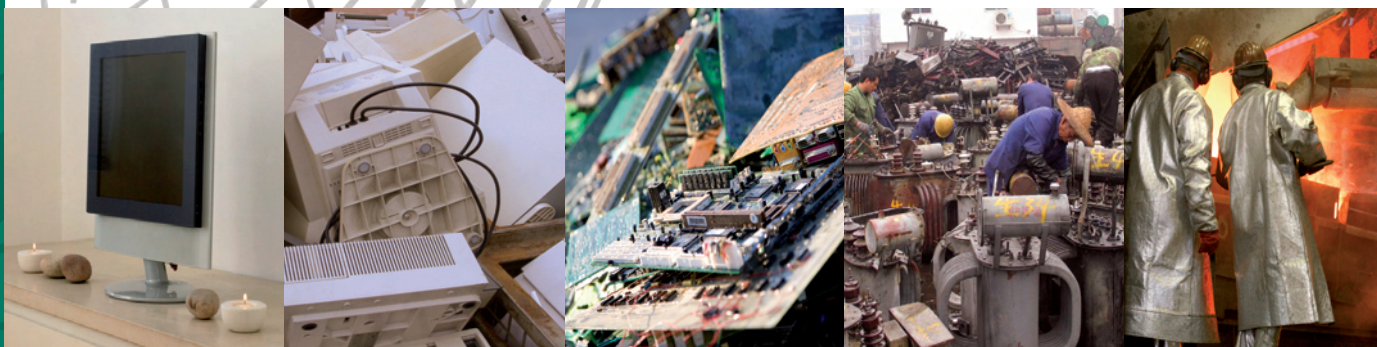

***Sustainable Innovation and
Technology Transfer
Industrial Sector Studies***

RECYCLING – FROM E-WASTE TO RESOURCES

UNITED NATIONS ENVIRONMENT PROGRAMME



Copyright © United Nations Environment Programme & United Nations University, 2009

This publication may be reproduced in whole or in part and in any form for educational or non-profit purposes without special permission from the copyright holder, provided acknowledgement of the source is made. UNEP and UNU would appreciate receiving a copy of any publication that uses this publication as a source.

No use of this publication may be made for resale or for any other commercial purpose whatsoever without prior permission in writing from the United Nations Environment Programme and United Nations University.

Disclaimer

The designations employed and the presentation of the material in this publication do not imply the expression of any opinion whatsoever on the part of the United Nations Environment Programme and United Nations University concerning the legal status of any country, territory, city or area or of its authorities, or concerning delimitation of its frontiers or boundaries. Moreover, the views expressed do not necessarily represent the decision or the stated policy of the United Nations Environment Programme and United Nations University, nor does citing of trade names or commercial processes constitute endorsement.

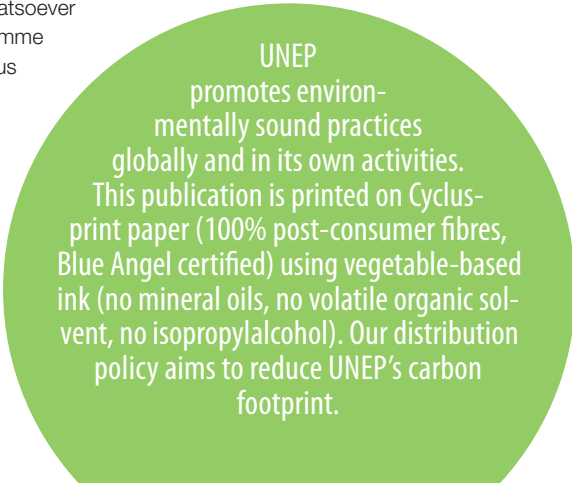

UNEP
promotes environ-
mentally sound practices
globally and in its own activities.
This publication is printed on Cyclus-
print paper (100% post-consumer fibres,
Blue Angel certified) using vegetable-based
ink (no mineral oils, no volatile organic sol-
vent, no isopropylalcohol). Our distribution
policy aims to reduce UNEP's carbon
footprint.

*Sustainable Innovation and
Technology Transfer
Industrial Sector Studies*

**RECYCLING-
FROM E-WASTE TO RESOURCES**

July 2009

Acknowledgements

Authors

Mathias Schluep^a
Christian Hagelueken^b
Ruediger Kuehr^c
Federico Magalini^c
Claudia Maurer^c
Christina Meskers^b
Esther Mueller^a
Feng Wang^c

^a Federal Laboratories for Material Testing and Research (EMPA)

^b Umicore Precious Metal Refining

^c United Nations University (UNU)

Supervision and technical editing

Guido Sonnemann, UNEP DTIE
Bas de Leeuw, UNEP DTIE

Design

Marcel Locher, UNEP DTIE

Printing

Oktoberdruck AG, Berlin, Germany

We would like to thank the following persons for their input and constructive comments:

Boin, Udo
Buffet, Elise (UNU)
Crock, Wesley (UNU)
Delgado, Clara (Gaiker)
Francomme, Magali (UNU)
Gregory, Jeremy (MIT)
Ott, Daniel (EMPA)
Rochat, David (EMPA)
Schischke, Karsten (FHG-IZM)

This study has been developed and reviewed within StEP Task Force “ReCycle”. It was prepared by the Swiss Federal Laboratories for Material Testing and Research (EMPA), Umicore Precious Metal Refining and the United Nations University (UNU), with the support from UNEP and the European Commission, Directorate-General for the Environment.

EXECUTIVE SUMMARY

Executive Summary

Sustainable Innovation, understood as the shift of sustainable technologies, products and services to the market, requires a market creation concept and one common global agenda. The challenge is to raise awareness among all actors of the different sectors in order to realize the innovation potential and to shift to eco-innovations that lead to sustainable consumption and production patterns.

Throughout this study prepared within the “Solving the E-Waste Problem (StEP) Initiative” the focus lies on a consistent set of different types of metals (ferrous and non-ferrous metals) such as aluminium (Al), copper (Cu), palladium (Pd) and gold (Au). Toxic and hazardous elements are present in e-waste, which are partially drivers for the implementation of sound collection and treatment processes. Therefore in the discussion of recycling technologies, the proper handling and treatment of such harmful elements to prevent environmental or health impact is included. Furthermore, the use and generation of toxic/hazardous substances during e-waste processing (for example, a mercury-gold amalgam or combined dioxins from inappropriate incineration) is critically evaluated with respect to the sustainability criteria for innovative technologies.

The study, structured in three parts, has the following three main objectives:

- (1) Analysis of the market potential of relevant technologies for the e-waste recycling sector in selected developing countries,
- (2) Examination of the application of the ‘Framework for UNEP Technology Transfer Activities in Support of Global Climate Change Objectives’ in order to foster the transfer of innovative technologies in the e-waste recycling sector,
- (3) Identification of innovation hubs and centres of excellence in emerging economies relevant for e-waste recycling technologies.

After an introduction to the objectives, scope and methodology of this study, the second chapter introduces the fundamentals of e-waste recycling, including:

- Significance of e-waste for resource management and toxic control,
- Structure and main steps in the recycling chain,
- Basic objectives to achieve for e-waste recycling,
- Innovation criteria for evaluation of technologies.

The appropriate handling of e-waste can both prevent serious environmental damage and also recover valuable materials, especially for metals. The recycling chain for e-waste is classified into three main subsequent steps: (i) collection, (ii) sorting/dismantling and pre-processing (including sorting, dismantling and mechanical treatment) and (iii) end-processing. All three steps should operate and interact in a holistic manner to achieve the overall recycling objectives. The main objectives of e-waste recycling and basic considerations for innovation are:

- Treat the hazardous fractions in an environmentally sound manner,
- Recover valuable material maximally,
- Create eco-efficient and sustainable business,
- Consider social impact and local context.

The general criteria to specific requirements for separation and dismantling of e-waste are given and sustainability attributes used as innovation criteria and to compare current and innovative technologies are divided into economic, environmental and social aspects.

In the third chapter available pre-processing technologies are described respectively in three categories of waste equipments: (i) cooling and freezing (C&F) appliances, (ii) information and communication technologies (ICT) appliances and (iii) monitors and

televisions (TVs). End-processing technologies are depicted for printed wiring boards and small electronic devices, metallic fractions with precious metals, other metallic fractions, and aluminium, ferrous and lead containing-glass from cathode ray tubes (CRT).

Current e-waste generation volumes for the selected 11 developing countries have been estimated, based on the e-waste data of personal computers, printers, mobile phones, televisions and refrigerators. Future generation of e-waste is estimated accordingly. It is indicated from the prediction that on average, a linear increase has been found for personal computers (PCs), TVs and refrigerators among the selected countries, while mobile phone sales and stocks showed an exponential growth in the past years.

The market potential is estimated as a function of possible volumes of e-waste available for recycling and the typical size of a recycling facility adapting a specific technology. Market potential of innovative pre-processing technologies are evaluated within the three criteria of (i) manual dismantling/ sorting of fractions, (ii) de-gassing chlorofluorocarbons (CFCs)/ hydrochlorofluorocarbons (HFCs) and (iii) semi-automatic CRT cut and cleaning for the selected 11 countries. Market potential of innovative end-processing technologies is assessed by the criteria of integrated smelter for non-ferrous (pyrometallurgical methods) and aluminium smelter/refiner for the target countries. By examining the actual performance of the recycling chains of both informal and formal recyclers in the selected countries, it has been shown that sustainable technologies exist as a result of individual or corporate initiatives. On the other hand a number of inefficient and unsustainable operations, which lack environmental, health and safety (EHS) standards and best practices, could have potential for future implementation of innovation technologies.

By examining the respective scale of the informal and formal sectors in the selected countries, the 11 countries have been grouped into three categories. Group A (Kenya, Uganda, Senegal, Peru) is classified as promising for the introduction of innovative pre-processing technologies with a strong support in capacity building. Group B (India, China) is classified as having a significant potential for the introduction of pre- and end-processing technologies with a strong support in capacity building in the informal sector. Group C (South Africa, Morocco, Colombia, Mexico, Brazil) is classified as having a significant potential to adapt pre- and to some extent end-processing technologies to their own needs, following a technology and knowledge exchange.

Barriers for the transfer of sustainable e-waste recycling technologies have been identified for each of the target countries for the different dimensions: (i) policy and legislation, (ii) technology and skills and (iii) business and financing. The listed barriers are also hindering the implementation of sustainable e-waste management systems in the countries under analysis.

By following the United Nations Environment Programme (UNEP) "Framework for Analysis: Technology Transfer to address Climate Change", South Africa and China are selected to introduce the strategic technology transfer programme for sustainable e-waste recycling technologies in the fourth chapter.

South Africa and China are identified to be promising examples for the application of the UNEP technology transfer framework. South Africa features advanced framework conditions with a strong engagement of the manufacturers and importers industry in e-waste management. China features large volumes and a large interest in e-waste recycling by the informal and the formal sector which defines a vibrant selection of technology transfer opportunities.

A technology transfer demands for a comprehensive framework considering all issues around (i) policy and legislation, (ii) technology and skills and (iii) business and financing in

order to be sustainable. In this respect potential barriers for the introduction of innovative technologies and intervention mechanisms, which correspond directly and indirectly to the aforementioned technology transfer issues, were identified and discussed. Regarding policy and legislation, the main barriers originate from the lack of specific legal frameworks, low national priority for the topic, conflicting existing legislation and uncoordinated enforcement of the law. With regard to technology and skills, barriers are primarily defined through the lack of EHS standards, the strong influence of the informal sector, the lack of collection infrastructure, cherry-picking activities and low skills and awareness. Additional barriers assigned to business and financing topics include limited industry responsibility, high costs of logistics, possible exploitation of workers from disadvantaged communities, crime and corruption and false consumer expectations.

Within the fifth chapter existing innovation hubs and knowledge centres of excellence in emerging economies have been identified in perspectives of involving stakeholders and their roles in influencing policy, research and industrial development. Relevant framework conditions and instruments for the development of these hubs and the barriers preventing the replication of locally developed technologies are analysed.

Due to the lack of awareness for e-waste recycling in emerging economies, innovation hubs and centres of excellence have not yet been established. However some organizations are currently establishing their e-waste competence and have a great potential to develop into innovation hubs. The current situation in China, India and South Africa indicate that smaller and less complex economies such as South Africa improve faster in awareness and competence.

Crucial instruments and framework conditions for the development of innovation hubs include the possibility to participate in international knowledge partnerships programmes. It also has been seen that without clear legal framework and active participation of the government the development of innovative technologies is hampered. The future success of technological innovation in environments with strong informal participation strongly depends on alternative business models with financial incentives, which allow the informal sector to still participate with “safe” recycling processes, while hazardous operations are transferred to state-of-the-art formal recyclers. The development of innovation hubs also demand for a fair, competitive environment with common rules, clearly favouring the development and application of innovative technologies.

Note de synthèse

L'innovation durable, comprise comme le passage à des technologies, produits et services durables sur le marché, nécessite un concept de création pour le marché et un programme mondial commun. Le défi consiste à sensibiliser tous les acteurs des différents secteurs afin de développer le potentiel d'innovation et passer à des éco-innovations qui entraîneraient la mise en place de modes de consommation et de production durables.

Dans cette étude préparée dans le cadre de l'initiative StEP (Solving the E-Waste Problem : résoudre le problème des e-déchets), l'accent est porté sur un ensemble cohérent de différents types de métaux (métaux ferreux et non-ferreux), tels que l'aluminium (Al), le cuivre (Cu), le palladium (Pd) et l'or (Au). C'est notamment en raison des éléments toxiques et dangereux, présents dans les e-déchets, que des processus de collecte et de traitement écologiques ont été mis en place. En conséquence, le maniement et le traitement appropriés de ces éléments nocifs en vue d'empêcher des impacts sur l'environnement et la santé font partie des débats sur les technologies de recyclage. De plus, l'utilisation et la génération de substances toxiques/dangereuses au cours du traitement des e-déchets (par exemple, un amalgame mercure/or ou une combinaison de dioxines due à une mauvaise incinération) sont évaluées très sérieusement par rapport au critère de durabilité pour les technologies durables.

L'étude, divisée en trois parties, a trois objectifs principaux:

- (1) Analyse du potentiel du marché pour les technologies pertinentes au secteur du recyclage des e-déchets dans les pays en développement sélectionnés,
- (2) Examen de la mise en œuvre du Cadre pour les activités de transfert de technologie du PNUE en vue d'atteindre les objectifs contre le changement climatique mondial (Framework for UNEP Technology Transfer Activities in Support of Global Climate Change Objectives) afin de promouvoir le transfert de technologies innovantes dans le secteur du recyclage des e-déchets,
- (3) Identification des pôles d'innovation et des centres d'excellence dans les économies émergentes qui seraient pertinents pour les technologies de recyclage des e-déchets.

Après la présentation des objectifs, du domaine d'application et de la méthodologie de cette étude, le deuxième chapitre présente les données fondamentales du recyclage des e-déchets, dont :

- L'importance des e-déchets dans la gestion des ressources et le contrôle des substances toxiques,
- La structure et les principales étapes de la chaîne de recyclage,
- Les objectifs élémentaires à atteindre dans le recyclage des e-déchets,
- Les critères d'innovation pour l'évaluation des technologies.

Le maniement approprié des e-déchets peut à la fois éviter de graves dégâts environnementaux et permettre de récupérer des matériaux de valeur, surtout en ce qui concerne les métaux. La chaîne de recyclage des e-déchets est classifiée en trois étapes successives principales : (i) collecte, (ii) tri/désassemblage et prétraitement (y compris tri, désassemblage et traitement mécanique) et (iii) traitement final. Ces trois étapes doivent fonctionner et interagir de manière holistique afin d'atteindre les objectifs globaux de recyclage. Les principaux objectifs du recyclage des e-déchets et les considérations élémentaires concernant l'innovation sont :

- Traiter les éléments dangereux de manière écologique,
- Optimiser la collecte des matériaux de valeur,
- Créer des activités éco-efficaces et durables,

- Prendre en compte l'impact social et le contexte local.

Les critères généraux des exigences spécifiques pour le tri et le désassemblage des e-déchets sont exposés dans ce chapitre et les caractéristiques de durabilité, utilisées comme critères d'innovation et pour comparer les technologies actuelles et les technologies innovantes, sont divisées selon les aspects économiques, environnementaux et sociaux.

Dans le troisième chapitre, les technologies de prétraitement disponibles sont décrites respectivement en trois catégories d'équipements producteurs de déchets : (i) appareils de refroidissement et de congélation, (ii) appareils des technologies de l'information et de la communication (TIC) et (iii) moniteurs et téléviseurs (TV). Les technologies de traitement final sont destinées aux circuits imprimés et aux petits dispositifs électroniques, aux éléments métalliques contenant des métaux précieux, aux autres éléments métalliques ainsi qu'à l'aluminium, aux composants ferreux et au verre plombé issus des tubes à rayon cathodique (TRC).

Les volumes actuels de production d'e-déchets pour les 11 pays en développement sélectionnés ont été estimés à partir de données sur les e-déchets issus des ordinateurs personnels, des imprimantes, des téléphones mobiles, des télévisions et des réfrigérateurs. Les productions futures d'e-déchets sont estimées en conséquence. Les prévisions indiquent qu'en moyenne, on observe dans les pays sélectionnés une augmentation linéaire pour les ordinateurs personnels (OP), les TV et les réfrigérateurs, alors que les ventes et les réserves de téléphones mobiles ont connu une croissance exponentielle au cours des dernières années.

Selon des estimations, le potentiel du marché est fonction des volumes possibles d'e-déchets disponibles pour le recyclage et de la taille classique d'une infrastructure de recyclage qui adapte une technologie spécifique. Le potentiel du marché des technologies de fin de traitement innovantes est évalué pour les 11 pays sélectionnés selon les trois critères de (i) démontage manuel/tri des éléments, (ii) chlorofluorocarbures (CFC) de dégazage/hydrofluorocarbures (HFC) et (iii) coupe et nettoyage des TRC semi-automatiques. Le potentiel du marché des technologies de fin de traitement innovantes est évalué pour les pays cibles selon l'existence d'une fonderie intégrée pour éléments non-ferreux (méthodes pyrométallurgiques) et d'une fonderie/raffinerie d'aluminium. En examinant le véritable rendement des chaînes de recyclage des entreprises des secteurs formels et informels dans les pays sélectionnés, on observe que les technologies durables existent suite à des initiatives individuelles ou collectives. D'un autre côté, un certain nombre d'activités inefficaces et non-durables, qui manquent de normes environnementales, sanitaires et de sécurité (EHS : environment, health and security) et de meilleures pratiques, pourraient disposer d'un certain potentiel pour l'installation de technologies innovantes.

En examinant l'échelle respective des secteurs formel et informel dans les pays sélectionnés, les 11 pays ont été divisés en trois catégories. Le groupe A (Kenya, Ouganda, Sénégal, Pérou) est classifié comme prometteur pour l'introduction de technologies de prétraitement innovantes avec un soutien important en renforcement des capacités. Le groupe B (Inde, Chine) est classifié comme ayant un potentiel significatif pour l'introduction de technologies de prétraitement et de fin de traitement avec un soutien important en renforcement des capacités dans le secteur informel. Le groupe C (Afrique du Sud, Maroc, Colombie, Mexique, Brésil) est classifié comme ayant un potentiel significatif pour adapter à leurs besoins les technologies de prétraitement et, dans une certaine mesure, les technologies de fin de traitement, après un échange de technologies et de connaissances.

Les barrières qui empêchent le transfert de technologies durables de recyclage des e-déchets ont été identifiées pour chaque pays cible selon les aspects suivants : (i) politiques et

législations, (ii) technologies et compétences et (iii) entreprises et finances. Ces barrières empêchent également la mise en place de systèmes de gestion durable des e-déchets dans les pays analysés.

Selon le Programme des Nations Unies pour l'Environnement (PNUE) « Cadre pour l'analyse : transfert de technologies contre le changement climatique » (Framework for Analysis: Technology Transfer to address Climate Change), l'Afrique du Sud et la Chine ont été choisies dans le quatrième chapitre pour introduire le programme stratégique de transfert de technologie pour les technologies durables de recyclage des e-déchets.

L'Afrique du Sud et la Chine ont été identifiées comme des exemples prometteurs pour la mise en œuvre du cadre de transfert de technologies du PNUE. L'Afrique du Sud présente des conditions-cadres avancées, ainsi qu'une forte implication du secteur de la construction et de l'importation dans la gestion des e-déchets. Quant à la Chine, elle présente d'importants volumes d'e-déchets et les secteurs formel et informel portent un grand intérêt dans leur recyclage, ce qui implique de nombreuses opportunités de transfert de technologies.

Afin d'être durable, un transfert de technologies nécessite un cadre global qui couvre tous les domaines ayant trait (i) aux politiques et législations, (ii) aux technologies et aux compétences et (iii) aux entreprises et aux finances. À cet égard, les barrières potentielles à l'introduction de technologies innovantes et de mécanismes d'intervention, qui correspondent directement et indirectement aux problèmes de transfert de technologies susmentionnés, ont été identifiées et analysées. En matière de politiques et de législations, les principales barrières viennent du manque de cadres juridiques spécifiques, de la faible priorité au niveau national sur ce sujet, des législations existantes incompatibles et de la mise en œuvre non-coordonnée de la loi. Au niveau des technologies et des compétences, les barrières viennent principalement du manque de normes EHS, de la forte influence du secteur informel, du manque d'infrastructures de tri, des activités de picorage¹, ainsi que du faible niveau de compétences et du manque de sensibilisation. D'autres barrières concernant les entreprises et les finances incluent la responsabilité limitée des industries, les coûts élevés de logistique, l'exploitation possible des travailleurs issus des communautés défavorisées, le crime et la corruption, ainsi que les fausses attentes des consommateurs.

Le cinquième chapitre fait état des pôles d'innovation et des centres de connaissances d'excellence présents dans les économies émergentes qui impliquent les parties prenantes et influencent les politiques, la recherche et le développement industriel. Ce chapitre analyse les conditions-cadres pertinentes et les instruments nécessaires au développement de ces pôles, ainsi que les barrières qui empêchent la reproduction des technologies développées au niveau local.

Les pôles d'innovation et les centres d'excellence n'ont pas encore été établis en raison du manque de sensibilisation élémentaire au recyclage des e-déchets dans les économies émergentes. Toutefois, certaines organisations sont actuellement en train de définir leurs compétences et possèdent un fort potentiel pour devenir des pôles d'innovation. La situation actuelle en Chine, en Inde et en Afrique du Sud indique que les économies plus petites et moins complexes, telles que l'Afrique du Sud, améliorent plus rapidement leur niveau de sensibilisation et de compétences.

Les instruments et les conditions-cadres essentielles au développement des pôles d'innovation incluent la possibilité de participer à des programmes internationaux de partenariat de connaissances. On remarque également qu'un cadre juridique confus et une

¹ Par picorage, on entend le fait de ne recycler que les éléments ayant de la valeur

participation passive du gouvernement entravent le développement de technologies innovantes. Le succès futur de l'innovation technologique dans des environnements avec une forte participation du secteur informel dépend beaucoup de modèles d'entreprise alternatifs bénéficiant d'incitations financières, qui permettent au secteur informel de continuer à participer aux processus de recyclage « sûrs », tandis que les opérations dangereuses sont transférées aux entreprises de recyclage de pointe du secteur formel. En outre, le développement de pôles d'innovations nécessite un environnement juste et concurrentiel avec des règles communes, qui favorise véritablement le développement et la mise en place de technologies innovantes.

Resumen ejecutivo

La innovación sostenible, entendida como la transferencia de tecnologías, productos y servicios sostenibles al mercado, requiere de un concepto de creación de mercado y de una agenda mundial común. El reto es la creación de conciencia entre todos los actores de los diferentes sectores a fin de desarrollar el potencial de innovación y llevar a la práctica las innovaciones ecológicas que llevan a un consumo sostenible y a pautas de producción.

Para todo este estudio elaborado en el marco de la iniciativa "Solve the E-Waste Problem (StEP)", el foco está en un conjunto coherente de diferentes tipos de metales (metales ferrosos y no ferrosos), tales como el aluminio (Al), el cobre (Cu), el paladio (Pd) y el oro (Au). Los residuos de aparatos eléctricos y electrónicos (RAEE) contienen elementos tóxicos y peligrosos, los cuales representan en parte la fuerza motriz para la implementación de procesos de recolección y procesamiento ambientalmente amigables. Por lo tanto, se incluyen el manejo y tratamiento adecuado para prevenir los impactos ambientales o de salud de dichos elementos nocivos en la discusión de las tecnologías de reciclaje. Además, el uso y la generación de sustancias tóxicas y peligrosas durante el procesamiento de los RAEE (por ejemplo, una amalgama de mercurio en oro o las dioxinas combinadas provenientes de una incineración inadecuada) son evaluados de manera crítica con respecto a los criterios de sostenibilidad para tecnologías innovadoras.

El estudio, estructurado en tres partes, tiene los siguientes tres objetivos principales:

- (1) El análisis del potencial de mercado de las tecnologías pertinentes para el sector de reciclaje de los RAEE en determinados países en desarrollo,
- (2) El examen de la solicitud del "Framework for UNEP Technology Transfer Activities in Support of Global Climate Change Objectives" (traduce: Marco para las Actividades de Transferencia de Tecnología del PNUMA en apoyo de los Objetivos del Cambio Climático Global) a fin de fomentar la transferencia de tecnologías innovadoras en el sector del reciclaje de los RAEE,
- (3) La identificación de centros de innovación y centros de excelencia en las economías emergentes relevantes para tecnologías de reciclaje de RAEE.

Después de una introducción a los objetivos, el alcance y la metodología de este estudio, el segundo capítulo presenta las bases del reciclaje de los RAEE, incluyendo:

- La importancia de los RAEE para la gestión de recursos y el control de tóxicos,
- La estructura y los principales pasos en la cadena de reciclaje,
- Los objetivos básicos a alcanzar para el reciclaje de los RAEE,
- Los criterios de innovación para la evaluación de tecnologías de reciclaje.

El manejo adecuado de los RAEE puede tanto prevenir graves impactos ambientales como recuperar materiales valiosos, especialmente en el caso de los metales. La cadena de reciclaje de los RAEE se divide en tres principales pasos posteriores: (i) recolección, (ii) clasificación/desmontaje y pre-procesamiento (incluye clasificación, desmontaje y procesamiento mecánico) y (iii) procesamiento final. Los tres pasos deben funcionar y relacionarse de manera integral para lograr los objetivos globales de reciclaje. Los objetivos principales del reciclaje de los RAEE y las consideraciones básicas para la innovación son los siguientes:

- Tratar las fracciones peligrosas de manera ambientalmente segura,
- Maximizar la recuperación del material valioso,
- Crear modelos de negocio eco-eficientes y sostenibles,
- Tener en cuenta los impactos sociales y el contexto local.

Los criterios generales de los requisitos específicos para la separación/clasificación y el desmontaje de los RAEE se conocen y los atributos de sostenibilidad utilizados como criterios de innovación y para comparar las tecnologías actuales e innovadoras se dividen en aspectos económicos, medioambientales y sociales.

En el tercer capítulo se describen las tecnologías de pre-procesamiento para tres categorías de RAEE: (i) los equipos de refrigeración, (ii) los equipos de las tecnologías de la información y las comunicaciones (TIC) y (iii) los monitores y televisores. Al final se presentan las tecnologías de procesamiento de tarjetas de circuito impreso y para pequeños dispositivos electrónicos, fracciones metálicas con metales preciosos, otras fracciones metálicas, y el vidrio con plomo, aluminio y hierro de los tubos de rayos catódicos (TRC).

Se estimaron los volúmenes de RAEE actualmente generados para 11 países en vía de desarrollo seleccionados, basados en los datos disponibles de computadores personales, impresoras, teléfonos móviles, televisores y neveras. Las estimaciones sobre cantidades venideras de RAEE se calcularon de manera correspondiente. Los pronósticos indican que para computadores, televisores y neveras el crecimiento en promedio es lineal para todos los países seleccionados, mientras que las ventas y los stocks de teléfonos móviles mostraron un incremento exponencial en los últimos años.

El potencial de mercado se estimó en función de los posibles volúmenes de RAEE disponibles para el reciclaje y el tamaño típico de una instalación de reciclaje empleando una tecnología específica. El potencial de mercado de tecnologías innovadoras de pre-procesamiento se evaluó dentro de los tres criterios de (i) desmontaje y clasificación manual de fracciones y componentes, (ii) extracción de clorofluorocarbonos (CFC) e hidroc fluorocarbonos (HFC), y (iii) corte semi-automático de TRC y limpieza para los 11 países seleccionados. El potencial de mercado de tecnologías innovadoras de procesamiento final se evaluó por criterios de refinería/fundición integrada para metales no ferrosos (métodos pirometalúrgicos) y la refinería/fundición de aluminio. Al examinar los resultados actuales de las cadenas de reciclaje de los gestores tanto informales como formales en los países seleccionados, se demostró que existen tecnologías sostenibles como resultado de iniciativas individuales o corporativas. Por otro lado, una serie de operaciones ineficientes e insostenibles que carecen estándares medioambientales, de salud y de seguridad ocupacional y buenas prácticas, demostraron tener un potencial considerable para una futura implementación de tecnologías innovadoras.

Mediante la evaluación de la respectiva escala de los sectores informales y formales en los países seleccionados, éstos se dividieron en tres grupos. El Grupo A (Kenia, Uganda, Senegal, Perú) se considera prometedor para la introducción de tecnologías innovadoras de pre-procesamiento con un fuerte apoyo en la creación de capacidades. El Grupo B (India, China) tiene un gran potencial para la introducción de tecnologías de pre-procesamiento y de procesamiento final con un fuerte apoyo en la creación de capacidades en el sector informal. Y el Grupo C (Sudáfrica, Marruecos, Colombia, México, Brasil) se caracteriza por su importante potencial para la adaptación de las tecnologías de pre-procesamiento y de procesamiento final a sus propias necesidades, a raíz del intercambio de tecnología y de conocimientos.

También se identificaron barreras para la transferencia de tecnologías sostenibles de reciclaje de los RAEE para cada uno de los países en cuestión, teniendo en cuenta aspectos de las tres áreas i) políticas y legislación, (ii) tecnologías y capacidades, y (iii) negocio y finanzas. En la lista figuran también los obstáculos que impiden la aplicación de la implementación de sistemas sostenibles de gestión de los RAEE en los países analizados.

Al seguir el programa de las Naciones Unidas para el Medio Ambiente (PNUMA) “Framework for Analysis: Technology Transfer to address Climate Change”, Sudáfrica y China fueron seleccionados en el cuarto capítulo para desarrollar el programa estratégico de transferencia de tecnología para tecnologías sostenibles de reciclaje de los RAEE.

Sudáfrica y China se identifican por ser ejemplos prometedores para la aplicación del marco de transferencia de tecnología de PNUMA. Sudáfrica se caracteriza por sus condiciones marco avanzadas con un fuerte compromiso de los fabricantes e importadores de aparatos eléctricos y electrónicos en el manejo de los RAEE. China por su lado ofrece grandes volúmenes y un gran interés en el reciclaje de los RAEE en los sectores informal y formal, ambas características que constituyen una selección atractiva de oportunidades de transferencia de tecnología.

Una transferencia de tecnología exige un marco amplio para examinar todas las cuestiones respecto a (i) políticas y legislación, (ii) tecnología y capacidades y (iii) negocios y finanzas con el fin de ser sostenible. En este sentido, se identificaron y discutieron posibles obstáculos para la introducción de tecnologías innovadoras y mecanismos de intervención, los cuales corresponden directa e indirectamente a los aspectos mencionados en el contexto de la transferencia de tecnología. En cuanto a *políticas y legislación*, los principales obstáculos proceden de la falta de marcos jurídicos específicos, la baja prioridad nacional del tema, los conflictos dentro de la legislación existente y la falta de aplicación de la ley. Con respecto a *tecnología y capacidades*, las barreras se definen principalmente por la falta de normas de seguridad industrial y ocupacional, la fuerte influencia del sector informal, la falta de infraestructura de recolección, “los que solamente se llevan la carne y dejan los huesos” (en inglés: “cherry-pickers”), la escasa formación y la falta de sensibilización. Barreras adicionales asignadas a los temas de *negocios y finanzas* incluyen la falta de responsabilidad por parte de la industria, altos costos de logística, la posible explotación de los trabajadores de comunidades desfavorecidas, la delincuencia, la corrupción y falsas expectativas de los consumidores.

En el quinto capítulo, se identifican los centros de innovación y los centros de conocimiento de excelencia en las economías emergentes desde la perspectiva de la participación de las partes interesadas y su papel en influir en las políticas, la investigación y el desarrollo industrial. Además se analizan las condiciones marco y los instrumentos para el desarrollo de estos centros y las barreras que impiden la reproducción de las tecnologías desarrolladas a nivel local.

Debido a la falta de conciencia y sensibilización para el reciclaje de RAEE en las economías emergentes, los centros de innovación y centros de excelencia aún no se han establecido. Sin embargo, algunas organizaciones actualmente están creando competencias en la gestión y el manejo de los RAEE y tienen un gran potencial para convertirse en centros de innovación. La situación actual en China, India y Sudáfrica indica que las economías más pequeñas y menos complejas, como por ejemplo la de Sudáfrica, por lo general son más rápidas en desarrollar conciencia y competencia en estos temas.

Los instrumentos y las condiciones marco fundamentales para el desarrollo de centros de innovación incluyen la posibilidad de participar en proyectos de cooperación internacional de gestión de conocimientos. También se observa que sin un marco jurídico claro y la participación activa de los gobiernos, el desarrollo de tecnologías innovadoras se ve obstaculizado. El éxito futuro de la innovación tecnológica en entornos con una fuerte participación informal depende en gran parte de modelos alternativos de negocio con incentivos financieros que permiten que el sector informal participe en procesos de reciclaje “seguros”, mientras que las operaciones peligrosas se transfieren a gestores formales con

tecnología de punta. El desarrollo de centros de innovación además requiere de un entorno justo y competitivo con normas comunes que favorecen claramente el desarrollo y la implementación de tecnologías innovadoras.

Abbreviations

Ag	Silver
AgCl	Silver chloride
Al	Aluminium
ARF	Advanced recycling fee
As	Arsenic
Au	Gold
B2B	Business to business
B2C	Business to consumer
Ba	Barium
BAT	Best available technologies
Be	Beryllium
Bi	Bismuth
Bo2W	Best of Two Worlds
Br	Bromine
°C	Degree Celsius
C&F	Cooling and freezing
Cd	Cadmium
CFCs	Chlorofluorocarbons
CIA	Central Intelligence Agency
Co	Cobalt
CO ₂	Carbon dioxide
CRT	Cathode ray tubes
Cu	Copper
CuSO ₄	Copper sulfate
EEE	Electrical and electronic equipment
EHS	Environmental, health and safety
Empa	Swiss Federal Laboratories for Materials Testing and Research
EOL	End-of-life
EPR	Extended producer responsibility
EU	European Union
EUR	Euro
Fe	Iron
FTE	Full time equivalent
GWP	Global warming potential
HCFCs	Hydrochlorofluorocarbons
HCl	Hydrochloric acid
HD	Hard drives
HFC	Hydrofluorocarbons
Hg	Mercury
HNO ₃	Nitric acid
IC	Integrated circuit
ICT	Information and communication technologies
In	Indium

Ir	Iridium
ISO	International Organization for Standardization
IT	Information technologies
ITO	Indium tin oxide
Kg	Kilogram
kg/cap.year	Kilogram per capita and year
LCD	Liquid chrystal display
Li-Polymer	Lithium polymer
LOI	Loss of ignition
Max	Maximum
Mg	Magnesium
Mm	Millimeter
Mn	Manganese
MoIC	Ministry of Information and Communication, Kenya
MSW	Municipal solid waste
NGO	Non-governmental organizations
Ni	Nickel
NiCd	Nickel cadmium
NiMH Li-ion	Nickel metal hybrid; lithium-ion
ODS	Ozone depleting substances
OEM	Original equipment manufacturer
Pb	Lead
PC	Personal computer
PCB	Polychlorinated biphenyls
Pd	Palladium
PEM	Proton exchange membrane
PET	Polyethylene terephthalate
PGM	Platinum group metals
Ppm	Parts per million
Pt	Platinum
PUR	Polyurethane
PWBs	Printed wiring boards
Rh	Rhodium
RoHS	Restriction on the use of Hazardous Substances
Ru	Ruthenium
Sb	Antimony
SCP	Sustainable consumption and production
Se	Selenium
Si	Silicon
Sn	Tin
SO ₂	Sulfur dioxide
Sr	Strontium
StEP Initiative	Solving the E-waste Problem Initiative
t/y	Tons per year
Te	Tellurium
TVs	Televisions

UNEP	United Nations Environment Programme
UNFCCC	United Nations Framework Convention on Climate Change
UNU	United Nations University
USD	US Dollar
USA	United States of America
UV	Ultraviolet
VOCs	Volatile organic compounds
WDI	World Development Indicators
WEEE	Waste electrical and electronic equipment
WFB	World Factbook
Zn	Zinc

Table of contents

EXECUTIVE SUMMARY	VI
ABBREVIATIONS	XVII
FIGURES AND TABLES	XXIII
1 INTRODUCTION	1
1.1 Background of the study	2
1.2 Aims and methodology of the study	3
2 FUNDAMENTALS OF E-WASTE RECYCLING	6
2.1 Significance of e-waste recycling	6
2.1.1 Impact on metal resources	7
2.1.2 Impact on the environment	9
2.2 Structure and main steps in the recycling chain	12
2.3 Objectives of e-waste recycling and basic considerations for innovation	16
2.4 Innovation criteria for evaluation of technologies	17
3 MARKETS FOR RECYCLING TECHNOLOGY	21
3.1 Innovative e-waste recycling technologies	21
3.1.1 Pre-processing technologies	22
3.1.1.1 Cooling and freezing appliances	22
3.1.1.2 ICT appliances	23
3.1.1.3 Monitors and TVs	25
3.1.1.4 Evaluation of pre-processing technologies	27
3.1.2 End-processing technologies	28
3.1.2.1 Printed wiring boards and small electronic devices	29
3.1.2.2 Metallic fractions with precious metals	33
3.1.2.3 Metallic fractions without precious metals	33
3.1.2.4 Aluminium	34
3.1.2.5 Ferrous Metals	36
3.1.2.6 Pb-glass from CRT	37
3.1.2.7 Evaluation of end-processing technologies	38
3.2 E-waste volumes in developing countries	41
3.2.1 Current e-waste flows	41
3.2.1.1 Personal computers	44
3.2.1.2 Printers	46

3.2.1.3	Mobile phones	46
3.2.1.4	Televisions.....	47
3.2.1.5	Refrigerators.....	49
3.2.2	Future e-waste flows	49
3.2.2.1	Personal computers.....	49
3.2.2.2	Mobile phones	50
3.2.2.3	TVs	50
3.2.2.4	Refrigerators.....	51
3.3	Market potential of innovative e-waste recycling technologies in selected developing countries	51
3.3.1	Market potential of innovative pre-processing technologies	51
3.3.2	Market potential of innovative end-processing technologies	53
3.3.3	Sustainability impacts of current processes versus innovative technologies.....	54
3.3.3.1	Impacts of current processes	54
3.3.3.2	Current processes versus innovative technologies.....	56
3.4	Comparative analysis and classification of countries.....	57
3.5	Identification of barriers for the transfer of sustainable e-waste recycling technologies	59
3.5.1	South Africa	59
3.5.2	Kenya	60
3.5.3	Uganda	61
3.5.4	Morocco.....	61
3.5.5	Senegal	62
3.5.6	Peru	62
3.5.7	Colombia	63
3.5.8	Mexico	64
3.5.9	Brazil.....	65
3.5.10	India.....	65
3.5.11	China	66
3.6	Assessment of mechanisms for technology transfer including financial mechanisms, technical support etc.....	67
3.7	Conclusion	70
4	APPLICATION OF A “TECHNOLOGY TRANSFER FRAMEWORK” FOR SELECTED RECYCLING TECHNOLOGIES.....	72
4.1	Methodology	72
4.2	Sustainable e-waste recycling technologies	72
4.3	Identification of two target countries for the application of innovation and technologies	73
4.4	Potential barriers and interventions	75

4.5	Conclusions	77
5	INNOVATION HUBS AND KNOWLEDGE CENTRES OF EXCELLENCE IN EMERGING ECONOMIES	78
5.1	Methodology	78
5.2	China.....	79
5.2.1	Potential innovation hubs and centres of excellence.....	79
5.2.2	Analysis of the general situation in China.....	79
5.3	India	80
5.3.1	Potential innovation hubs and centres of excellence.....	80
5.3.2	Pilot study informal “wet-chemical leaching” in Bangalore	81
5.4	South Africa	82
5.4.1	Potential innovation hubs and centres of excellence.....	82
5.4.2	Pilot project formalized “Material Recovery Facility” in Cape Town.....	82
5.5	Multi-lateral institutions	83
5.5.1	National Cleaner Production Centres (NCPCs).....	83
5.5.2	Basel Convention Regional Centres (BCRCs)	83
5.6	Conclusions	84
6	REFERENCES.....	85

Figures and Tables

Figure 1: Material content mobile phone [Source Umicore 2008]	7
Figure 2: Impact of phones and PCs on metals demand, based on global sales 2007	8
Figure 3: CO ₂ emissions of primary metal production calculated using the EcoInvent 2.0 database	10
Figure 4: Use of ODS in cooling and freezing appliances over the years [24]	11
Figure 5: Recycling chain	13
Figure 6: Deep-level manual dismantling of hard disks (left) and dismantling table with pneumatic tools (right)	24
Figure 7: Semi-automatic line for cutting (hot wire) of CRT and removal of coatings	26
Figure 8: Umicore integrated smelting/refining operations*	31
Figure 9: Distribution of aluminium recyclers in the world (2004) [43].....	34
Figure 10: Salt slag treatment in the aluminium recycling process	36
Figure 11: Quantities of PC put on the market in kg/cap-year.....	45
Figure 12: Quantities of e-waste generated from PCs in kg/cap-year.....	46
Figure 13: Quantities of mobile phones put on the market in kg/cap-year	47
Figure 14: Quantities of e-waste generated from mobile phones in kg/cap-year	47
Figure 15: Quantities of televisions put on the market in kg/cap-year	48
Figure 16: Quantities of e-waste generated from televisions in kg/cap-year.....	48
Figure 17: Quantities of e-waste generated from PCs in metric tons from 2005 - 2020	50
Figure 18: Comparative analysis of selected developing countries regarding the dimension of the formal and informal e-waste recycling sector	58
Table 1: Important metals used for electric and electronic equipment (based on demand in 2006)	9
Table 2: Global Warming Potential of refrigerants	11
Table 3: Separation and dismantling criteria for e-waste	18
Table 4: Sustainability attributes used as innovation criteria and to compare current and innovative technologies.....	19
Table 5: Pre-processing technologies available in the recycling chain of cooling and freezing appliances	23
Table 6: Pre-processing technologies available in the recycling chain of ICT appliances ...	25
Table 7: Pre-processing technologies available in the recycling chain of cooling and freezing appliances	27
Table 8: Identification of innovative pre-processing technologies for developing countries in the e-waste recycling chain	28
Table 9: Detailed qualitative sustainability analysis for state-of-the-art integrated smelters for printed wiring boards (PWBs) and aluminium smelters.....	39
Table 10: Identification of innovative end-processing technologies in the e-waste recycling chain	40
Table 11: Estimated Weight and Lifespan of EEE	41
Table 12: Quantity of EEE put on the market in metric tons/year	42
Table 13: Stock (installed base) of EEE in metric tons/year	43
Table 14: Quantity of e-waste generated in metric tons/year.....	44
Table 15: Typical volumes processed in pre-processing recycling facilities	52
Table 16: Market potential of identified innov. pre-processing technologies by country	53

Table 17: Size of global facilities for the end-processing of e-waste material fractions	54
Table 18: Market potential of the identified innovative end-processing technologies by country	54
Table 19: Informal and formal processes in the e-waste recycling chain in selected developing countries	56
Table 20: Selection of recycling technologies with the most promise to help create a more sustainable recycling sector in developing countries	73
Table 21: Summary of potential barriers to, and possible interventions in support of a successful transfer of sustainable recycling technologies in South Africa (SA) and China.....	76

FINAL REPORT

1 Introduction

Over the last decades the electronics industry has revolutionized the world: electrical and electronic products have become ubiquitous of today's life around the planet. Without these products, modern life would not be possible in (post-)industrialized and industrializing countries. These products serve in such areas as medicine, mobility, education, health, food-supply, communication, security, environmental protection and culture. Such appliances include many domestic devices like refrigerators, washing machines, mobile phones, personal computers, printers, toys and TVs.

The amount of appliances put on market every year is increasing both in (post-) industrialized and industrializing countries:

- In the European Union (EU) the total weight of electronic appliances put on the market in 2005 ranged up to more than 9.3 million tons with a sensible growing rate, particularly in Eastern Europe. Electronic appliances put on the market included [18]:
 - 44+ million large household appliances in EU15,
 - 48 million desktops and laptops,
 - Approximately 32 million TVs,
 - 776 million lamps,
- In the United States of America (USA), in 2006, more than 34 million TVs and displays have been placed on the market, while more than 24 million PCs and roughly 139 million portable communication devices such as cell phones, pagers or smart-phones have been manufactured [103]. It has to be highlighted that in the last couple of years the highest growth rate has occurred in communication devices: less than 90 million were sold in 2003, whereas 152 million are expected to be sold in 2008,
- India had an installed base of about 5 million PCs in 2006, which is contributing to the 25% compounded annual growth rate in the Indian PC industry [104],
- In China [105] roughly 14 million PCs were sold in 2005, as well as more than 48 million TVs, nearly 20 million refrigerators and 7.5 million air conditioners in 2001, both growth rate and market penetration are increasing year by year,
- GSM Association estimates that 896 million mobile phone handsets were sold in 2006 worldwide [106].

Currently, the available data on e-waste arising is poor and insufficient and estimation techniques are required for extension of known data to regional-global coverage. United Nations University's estimations indicate that current e-waste arising across the twenty-seven members of the European Union amount to around 8.3 – 9.1 million tons per year; global arising are estimated to be around 40 million tons per year [18].

Treatment processes of e-waste aim at either removing the hazardous items or at separation of as much as possible of the main recyclable materials (e.g. metals, glass and plastics), but achieving both objectives would be most desired. Although very limited information on e-waste treatment capacity in the EU Member States can be obtained, it is likely that the EU15 Member States should have had installed sufficient capacity to treat collected e-waste already by the middle of 2007. The situation in Central and Eastern Europe is likely to be different and it currently appears that a regional approach will be adopted. For example, Lithuania is planning to serve the Baltic States' needs and Hungary is expected to provide capacity for its neighboring countries, which will include Bulgaria and Romania.

Given the very limited data availability on amounts of e-waste collected and treated through "official" e-waste system channels, it is clear that the management of significant

proportions of e-waste currently go unreported [18] in Central and Eastern Europe. Moreover, the alarming and increasing reports on the e-waste situation in e.g. China, Nigeria, Pakistan and Ghana [5][6][7][8], in addition to the stocktaking of the situation in many more African and Latin American nations as part of the global “Solving the E-waste Problem (StEP) Initiative”, illustrate the urgent need to transfer and install appropriate and innovative technologies in the industrializing world.

Within relevant literature on environmental problems, the terms “technique” and “technology” are often used synonymously. However, the terms “technique” and “technology” are not synonymous within the e-waste discussion as “technique” refers to methods of creating new tools, establishing products of tools and the capacity for constructing such artefacts. [108]. Contrastingly, the definition of “technology” implies the know-how required to develop and apply techniques and technical procedures. Thus it exists embodied in machinery and equipment and unembodied in blueprints, technical instructions, manuals etc.[109][110].

Consequently, the term “technology” reflects four different dimensions as summarized by Hillebrand [111]:

- (1) The specific configuration of techniques and thus machinery and equipment designed to production process or for the provision of services, which can be summarized under the term “technical hardware”,
- (2) The scientific and technical knowledge, formal qualifications and experienced-based knowledge, what Hildebrand calls know-how,
- (3) The management methods used to link technical hardware and know-how, known under organization,
- (4) The physical good or service emerging from the production process and thus entitled “product”.

Based on the above, this report implies that technologies are not only technical installations, but also skills, processes and combinations thereof. In this respect, e.g. also a systematic manual dismantling of an electronic device or a well elaborated chain of different processes is regarded as technology and can be defined as innovative.

1.1 Background of the study

UNEP DTIE has commissioned UNU in August 2008 to carry out a small scale funding project entitled "Recycling– from E-waste to Resources" in line with the activities agreed on in the grant signed between UNEP and the European Commission and in relation to UNEP’s work on Sustainable Innovation.

UNEP defines Sustainable Innovation as the shift of sustainable technologies, products and services to the market, which requires a market creation concept and one common global agenda. The challenge is to raise awareness among all actors of the different sectors in order to realize the innovation potential and to shift to eco-innovations that lead to sustainable consumption and production patterns.

With regard to their environmental sustainability impacts and the greatest promise for successful innovations that would lead to a reduction in these impacts, UNEP made a selection of the most relevant topics. Based on the discussions at the first meeting on Sustainable Innovation and Technology Transfer and consultations with stakeholders, the need for this study on "Recycling– from E-waste to Resources" has been identified.

The results of this study will feed into the work of the UNEP Resource Panel, the preparation of the 10-year Framework of Programmes on Sustainable Consumption and Production (Marrakech Process), and hence into the '2010/2011 cycle' of the United Nations Commission on Sustainable Development.

Since this study takes a life cycle approach, the outcomes support the Life Cycle Initiative's task to enable users around the world to put life cycle approaches into effective practice. Furthermore, the activities will help UNEP to implement the Bali Strategic Plan for Technology Support and Capacity-Building.

And finally it also informs the activities of the StEP Initiative and its future agenda towards a sustainable solution of the growing e-waste problem.

1.2 Aims and methodology of the study

In order to achieve the call 'From Waste to Resources', an integrated waste policy and management, which addresses environmental impacts along the whole life-cycle of products, materials and processes, is crucial. According to the 3R Principle – Reduce, Reuse, Recycle, recycling reduces waste going to final disposal, decreases consumption of natural resources and improves energy efficiency. It is, in this respect, a key process, which can be improved through innovative and more effective processes and technologies. With respect to the 3R Principle the focus of this study is on recycling. Nevertheless, emphasis on reuse as an important part in this hierarchy is necessary by underlining the needs of appropriate collection, careful dismantling and creation of output qualities suitable for reuse. However, reused products or components thereof will have to be recycled in an environmentally sound way, as reuse is not really an alternative to recycling but an extension of lifetime before a product is recycled. In this respect this study does not look explicitly into technologies related to reuse but focuses instead on recycling technologies.

More collection of electrical and electronic appliances allows for more efficient recycling, keeps valuable e-waste components (e.g. metals) in the economy and safely disposes of its harmful components in order to prevent risks to human health and the environment. Therefore, increased take-back and innovative recycling technologies at the different steps of the recycling chain can generate genuinely sustainable products and services and can create new markets. Products that are designed with the possibilities and limitations of recycling in mind (Design for Recycling/ Design for Sustainability) can further facilitate recycling. This aspect is beyond the scope of this study and thus not discussed in more detail.

However, especially in developing countries, the barriers for innovative and sustainable e-waste recycling technologies can be difficult to overcome. Consequently, recycling technologies have to be identified for a range of framework conditions and e-waste products. Throughout this study the focus lies on a consistent set of metals (ferrous and non-ferrous metals) such as aluminium (Al), copper (Cu), palladium (Pd) and gold (Au). In e-waste toxic and hazardous elements are also present, which are partially drivers for the implementation of sound collection and treatment processes. Therefore in the discussion of recycling technologies, the proper handling and treatment of these kinds of elements to prevent environmental or health impact is included. Furthermore, the use and generation of toxic/hazardous substances during e-waste processing (e.g. mercury in gold amalgamation or dioxins from inappropriate incineration) is critically evaluated with respect to the sustainability criteria for innovative technologies.

The study, structured in three parts, has the following three main objectives:

- (1) Analysis of the market potential of relevant technologies for the e-waste recycling sector in selected developing countries,
- (2) Examination of the application of the 'Framework for UNEP Technology Transfer Activities in Support of Global Climate Change Objectives' in order to foster the transfer of innovative technologies in the e-waste recycling sector,
- (3) Identification of innovation hubs and centres of excellence in emerging economies relevant for e-waste recycling technologies.

(i) Markets for recycling technologies

The creation of markets can be regarded as the basis of technology transfer. The main drivers for the creation of recycling and recycling technologies markets are economic and regulatory factors. However, the market potential of e-waste recycling technologies and the framework conditions vary between countries and regions. Specifically, the most promising technologies for e-waste recycling need to be identified and fostered through relevant instruments. Particularly in many developing countries tools and instruments are required that promote the finance of collection and transfer of technology innovation in the field of e-waste recycling. This would save costs, energy and natural resources and could help countries to be less dependent on raw materials prices.

The key objectives of the first part of this study are:

- Analysis of the market potential of relevant technologies for the e-waste recycling sector in selected developing countries including estimates for the quantities of e-waste,
- Classification of countries according to their current market situations and framework conditions for e-waste recycling technologies.

First, the study gives an overview of the different e-waste treatment techniques/technologies; second, it provides an overview of the different market potentials and identifies policies and instruments that could support sustainable (both high and low tech) e-waste recycling techniques in developing and developed countries.

The above objectives were pursued by project experiences of the study-consortium, means of literature reviews and market reports. The analysis focuses on a high number of suitable technologies for e-waste recycling and geographical settings. The study looks at a timeframe until 2020 and wherever possible beyond.

(ii) Test the application of a technology transfer framework for selected recycling technologies

UNEP benefits from its long term experience in promoting technology transfer, namely under the Bali Strategic Plan on Technology Support and Capacity Building in developing countries as well as in countries with economies in transition. A "Framework for UNEP Technology Transfer Activities in Support of Global Climate Change Objectives", which is currently being discussed and developed within UNEP, foresees to undertake a range of activities to promote the diffusion of cleaner technologies in support of the objectives of the United Nations Framework Convention on Climate Change (UNFCCC).

Testing the application of this Framework for Technology Transfer to other innovative sustainable technologies, such as recycling technologies, is the key objective of this second part of the study. Its application is tested for the most promising recycling technologies and few selected industrializing countries while identifying barriers that hamper and instruments that could foster the transfer of innovative technologies in the e-waste recycling sector. The outcome of the chapter is two-fold. Firstly, the suitability of the Framework to support the

implementation of technology transfer is evaluated. Secondly, suitable instruments and other support measures for development of e-waste recycling technologies in industrializing countries are discussed.

The activities were carried out based on the findings of part 1 described above.

**(iii) Innovation hubs and knowledge centres of excellence in emerging economies
– The example of locally developed recycling technologies**

Sustainable innovation aims at a successful generation and commercialization of innovative technologies for achieving sustainable development and sustainable consumption and production (SCP) patterns. Hence, sustainable technology innovation is an important driver for economic growth and productivity. It helps to reduce poverty and aids in minimizing negative environmental and health impacts. Sustainable innovation is a critical dimension for developing countries and transitional economies. Without sustainable innovation these developing countries will remain disadvantaged and unable to make a shift to clean and resource efficient technologies and sustainable economic growth. Technology transfer and capacity building are also critical tools to implement innovation in emerging economies. However, simply copying innovative technologies from (post)-industrialized to industrializing economies does not necessarily generate the most sustainable solutions. Thus, capacity building and the fostering, coordinating and strengthening of existing regional capacities are essential for enabling industrializing countries to stimulate local development of sustainable technologies and innovation and to allow them to experience progress and sustainable livelihoods.

The key objectives of this third part of the study are:

- Identification and analysis of the existing innovation hubs and centres of excellence in emerging economies relevant for e-waste recycling technologies,
- Analysis of relevant framework conditions and instruments for the development of these hubs and the barriers preventing the replication of technologies they have locally developed.

The activities were based on the expertise of the project consortium, carried out by the means of literature reviews and built on the findings of part 1 and 2 as described above.

Key sources are long term experiences, findings and data gathering from Empa, Umicore, UNU and other StEP members, and the findings and environmental calculations of the environmental impact assessment are part of the UNU study supporting the European Commission's 2008 Review of the Directive 2002/96/EC on waste electrical and electronic equipment (WEEE) [15].

2 Fundamentals of e-waste recycling

As basis for the following chapters, it is essential to understand the fundamental issues underlying e-waste recycling. These are independent of the recycled material, the device and the recycling location or region and address the:

- Significance of e-waste for resource management and toxic control,
- General structure, main steps and interfaces of the recycling chain,
- Objectives to achieve,
- General frame conditions which impact process selection.

2.1 Significance of e-waste recycling

E-waste is usually regarded as a waste problem, which can cause environmental damage if not dealt with in an appropriate way. However, the enormous resource impact of electrical and electronic equipment (EEE) is widely overlooked. Summarizing the lack of closing the loop for electronic and electrical devices leads not only to significant environmental problems but also to systematic depletion of the resource base in secondary materials.

Modern electronics can contain up to 60 different elements; many are valuable, some are hazardous and some are both. The most complex mix of substances is usually present in the printed wiring boards (PWBs). In its entirety electrical and electronic equipment is a major consumer of many precious and special metals and therefore an important contributor to the world's demand for metals. Despite all legislative efforts to establish a circular flow economy in the developed countries/EU, the majority of valuable resources today are lost. Several causes can be identified: firstly, insufficient collection efforts; secondly, partly inappropriate recycling technologies; thirdly, and above all large and often illegal exports streams of e-waste into regions with no or inappropriate recycling infrastructures in place. Large emissions of hazardous substances are associated with this. Unfortunately, these regions with inappropriate recycling infrastructure are often located in developing and transition countries. At the moment the developing and transition countries are striving to implement technologies to deal with the recycling of e-waste and to establish circular flow economies.

Besides the direct impact of effective recycling on the resource base of the recycled metals, state of the art recycling operations² also considerably contribute to reducing greenhouse gas emissions. Primary production, i.e. mining, concentrating, smelting and refining, especially of precious and special metals has a significant carbon dioxide (CO₂) impact due to the low concentration of these metals in the ores and often difficult mining conditions. "Mining" our old computers to recover the contained metals – if done in an environmentally sound or correct manner – needs only a fraction of energy compared to mining ores in nature[1].

Furthermore, the environmentally sound management of refrigerators, air-conditioners and similar equipment is significant in mitigating the climate change impact at end-of-life. The ozone depleting substances in these devices, such as CFC and HCFCs, have a very high

² State of the art recycling operations are recycling operations that employ the best available technology in industry, which has proven to meet environmental legislation (European standard), which can show that high resource efficiency is obtained via scientifically proven mass balances, and which can show the final fate of its by- and waste products.

global warming potential (GWP) [24] and effective recycling will ensure these substances are not released into the environment. In that sense there is still a lot to win [18].

Essentially, the environmental footprint of a fridge, a computer and other electronic devices could be significantly reduced if treated in environmentally sound managed recycling operations, which prevent hazardous emissions and ensure that a large part of the contained metals are finally recovered for a new life in a new (electronic) device.

2.1.1 Impact on metal resources

A wide range of components made of metals, plastics and other substances are contained in electrical and electronic equipment. For example, a mobile phone can contain over 40 elements from the periodic table including base metals like copper (Cu) and tin (Sn), special metals such as cobalt (Co), indium (In) and antimony (Sb), and precious metals including silver (Ag), gold (Au) and palladium (Pd), as shown in Figure 1. Metals represent on average 23% of the weight of a phone, the majority being copper, while the remainder is plastic and ceramic material. Looking at one ton of phone handsets (without battery) this would be 3.5 kg Ag, 340 g Au, 140 g Pd as well as 130 kg Cu. For a single unit the precious metal content is in the order of milligrams only: 250 mg Ag, 24 mg Au, 9 mg Pd while 9 g Cu is present on average. Furthermore, the Li-ion battery of a phone contains about 3.5 g Co [1].

At first sight this appears to be very little, but taking into account the leverage of 1.2 billion mobile phones sold globally in 2007, this leads to a significant metal demand in total [2]. When looking at PCs and laptops, numbers in a similar order of magnitude are found (Figure 2). Also, the use of more common metals such as iron in electronics is considerable: about 6 kg iron/steel for a desktop PC [98] means 930,000 tons are used to manufacture the PCs sold in 2007. The combined 2007 unit sales of mobile phones and personal computers already add up to 3% of the world mine supply of Au and Ag, to 13% of Pd and to 15% of Co (Figure 2).

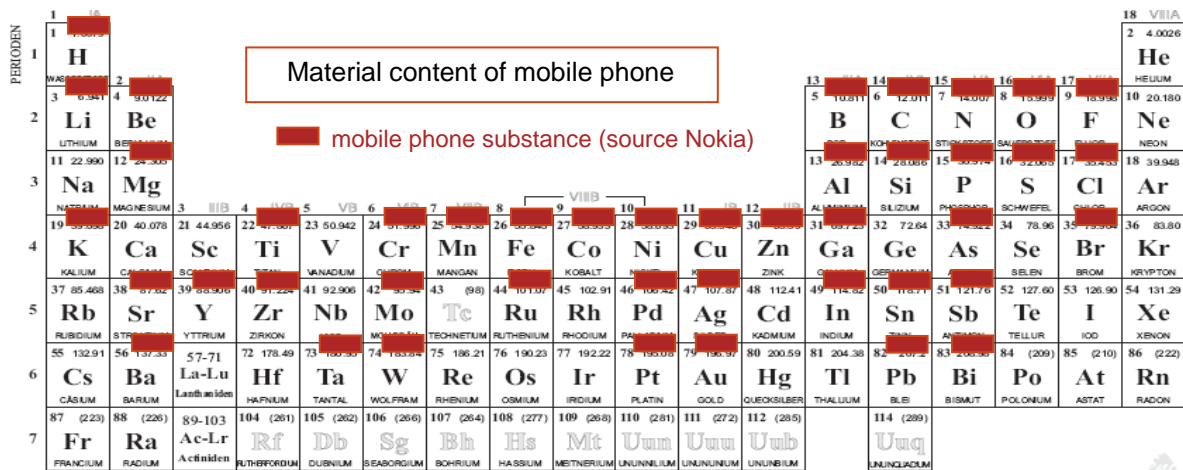

Figure 1: Material content mobile phone [Source Umicore 2008]



<p>a) Mobile phones: </p> <p>1200 Million units</p> <ul style="list-style-type: none"> x 250 mg Ag ≈ 300 t Ag x 24 mg Au ≈ 29 t Au x 9 mg Pd ≈ 11 t Pd x 9 g Cu ≈ 11,000 t Cu <p>1200 M x <u>20 g/battery*</u></p> <ul style="list-style-type: none"> x 3.8 g Co ≈ 4500 t Co <p>* Li-Ion type</p>	<p>b) PC & laptops: </p> <p>255 Million units</p> <ul style="list-style-type: none"> x 1000 mg Ag ≈ 255 t Ag x 220 mg Au ≈ 56 t Au x 80 mg Pd ≈ 20 t Pd x ≈ 500 g Cu ≈ 128,000 t Cu <p>≈100 M <u>laptop batteries*</u></p> <ul style="list-style-type: none"> x 65 g Co ≈ 6500 t Co <p>* Li-Ion type is > 90% used in modern laptops</p>	<table border="0"> <thead> <tr> <th>World Mine Production</th> <th>a+b share</th> </tr> </thead> <tbody> <tr> <td>Ag: 20,000 t/y</td> <td>▶ 3%</td> </tr> <tr> <td>Au: 2,500 t/y</td> <td>▶ 3%</td> </tr> <tr> <td>Pd: 230 t/y</td> <td>▶ 13%</td> </tr> <tr> <td>Cu: 16 Mt/y</td> <td>▶ 1%</td> </tr> <tr> <td colspan="2"> </td> </tr> <tr> <td>Co: 60,000 t/y</td> <td>▶ 15%</td> </tr> </tbody> </table>	World Mine Production	a+b share	Ag: 20,000 t/y	▶ 3%	Au: 2,500 t/y	▶ 3%	Pd: 230 t/y	▶ 13%	Cu: 16 Mt/y	▶ 1%			Co: 60,000 t/y	▶ 15%
World Mine Production	a+b share															
Ag: 20,000 t/y	▶ 3%															
Au: 2,500 t/y	▶ 3%															
Pd: 230 t/y	▶ 13%															
Cu: 16 Mt/y	▶ 1%															
Co: 60,000 t/y	▶ 15%															

Figure 2: Impact of phones and PCs on metals demand, based on global sales 2007 [Source Umicore 2008]

Taking into account the highly dynamic growth rates of all the other electronic devices such as liquid crystal display (LCD)-TVs and monitors, MP3 players, electronic toys and digital cameras, it becomes clear that electrical and electronic equipment is a major driver for the development of demand and prices for a number of metals as shown in Table 1. In particular the booming demand for precious and special metals is linked to increasing functionality of the products and the specific metal properties needed to achieve these. For example, electronics make up for almost 80% of the world's demand of indium (transparent conductive layers in LCD glass), over 80% of ruthenium (magnetic properties in hard disks (HD)) and 50% of antimony (flame retardants). Some of these metals are also important for renewable energy generation: selenium (Se), tellurium (Te) and indium (In) are used in thin film photovoltaic panels; platinum (Pt) and ruthenium (Ru) are used for proton exchange membrane (PEM) fuel cells³. Some metal price increases, which we have observed over the last years are directly connected to the developments in the electronic industry. The monetary value of the annual use of important "electrical and electronic equipment metals" represents USD 45.4 billion at 2007 price levels.

The metal resources used yearly for electrical and electronic equipment are added to the existing metal resources in society of the devices in use. These metal resources become available again at final end-of-life of the devices. As mentioned earlier this is a potential material resource of 40 million tons each year. Effective recycling of the metals/materials is crucial to keep them available for the manufacture of new products, be it electronics, renewable energy applications or applications not invented yet. In this manner primary metal and energy resources can be conserved for future generations.

³ PEM fuel cells are currently considered most suitable for use in automotive and portable electronics applications.

Metal	Primary production*	By-product from	Demand for EEE	Demand/ production	Price**	Value in EEE**	Main applications
	t/y		t/y	%	USD/kg	10 ⁶ USD	
Ag	20 000	(Pb, Zn)	6 000	30	430	2.6	Contacts, switches, solders...
Au	2 500	(Cu)	300	12	22 280	6.7	Bonding wire, contacts, integrated circuits...
Pd	230	PGM	33	14	11 413	0.4	Multilayer capacitors, connectors
Pt	210	PGM	13	6	41 957	0.5	Hard disk, thermocouple, fuel cell
Ru	32	PGM	27	84	18 647	0.5	Hard disk, plasma displays
Cu	15 000 000		4 500 000	30	7	32.1	Cable, wire, connector...
Sn	275 000		90 000	33	15	1.3	Solders
Sb	130 000		65 000	50	6	0.4	Flame retardant, CRT glass
Co	58 000	(Ni, Cu)	11 000	19	62	0.7	Rechargeable batteries
Bi	5 600	Pb, W, Zn	900	16	31	0.03	Solders, capacitor, heat sink...
Se	1 400	Cu	240	17	72	0.02	Electro-optic, copier, solar cell
In	480	Zn, Pb	380	79	682	0.3	LCD glass, solder, semiconductor
Total			4 670 000			45.4	

* Rounded from [9], [10], [11]. ** Using the average price in 2007.

Table 1: Important metals used for electric and electronic equipment (based on demand in 2006)

2.1.2 Impact on the environment

Primary production (mining) plays the most important role in the supply of metals for electrical and electronic equipment applications since secondary metals (recycling) are only

available in limited quantities so far. The environmental impact/footprint of the primary metal production is significant, especially for precious and special metals which are mined from ores in which the precious and special metal concentration is low. Considerable amounts of land are used for mining, waste water and sulfur dioxide (SO₂) are created and the energy consumption and CO₂ emissions are large. For example, to produce 1 ton of gold, palladium or platinum, CO₂ emissions of about 10,000 tons are generated [3]. Conversely the production of copper has only an emission of 3.4 t CO₂ per ton metal (Figure 3). Combining these numbers with the metal usage in electrical and electronic equipment (given in Table 1) enables calculation of the CO₂ emissions associated with the primary production of the metals as shown in the table of Figure 3. For example, the annual demand for gold in EEE is some 300 t at average primary generation of almost 17,000 tons CO₂ per ton of gold mined, which leads to gold induced emissions of 5.1 million tons in total. In the case of copper, the specific primary emissions are with 3.4 t/t relatively low, but the high annual total demand in EEE leads to 15.3 million tons of CO₂ emissions. As shown in Figure 3 (table) the cumulated values of the metals listed account for an annual CO₂ emission level of 23.4 million tons, almost 1/1000 of the world's CO₂ emissions. This includes neither CO₂ emissions from other metals used in electrical and electronic equipment like steel, nickel or aluminium, nor other CO₂ emissions associated with the manufacturing or use of electrical and electronic equipment.

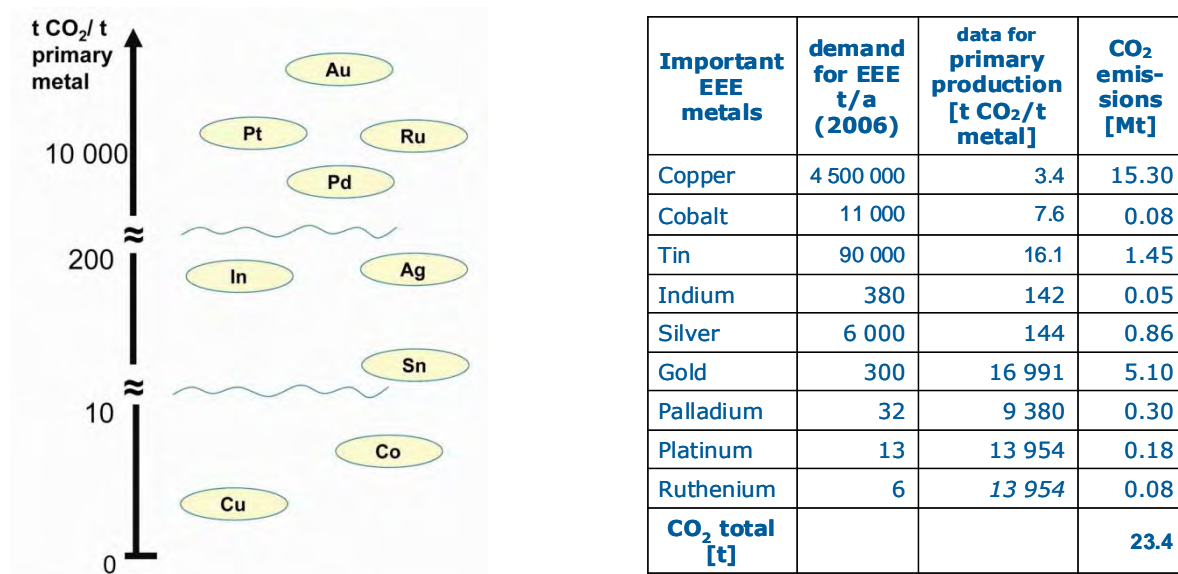

Figure 3: CO₂ emissions of primary metal production calculated using the Ecolvent 2.0 database

Recovering metals from state-of-the art recycling processes generates only a fraction of these CO₂ emissions and also has significant benefits compared to mining in terms of land use and hazardous emissions [1]. For example, production of 1 kg aluminium by recycling uses only 1/10 or less of the energy required for primary production, and prevents the creation of 1.3 kg of bauxite residue, 2 kg of CO₂ emissions and 0.011 kg of SO₂ emissions as well as the impacts and emissions associated with the production of the alloying elements used in aluminium. Furthermore, the salt slag created during the recycling process is treated to recover salt flux for the recycling industry, inert oxides for cement industry and aluminium

metal [15], [16], [17]. For precious metals the specific emissions saved by state-of-the-art recycling are even higher [1].

The substances contained in the devices can also have an impact on the environment. Cooling and freezing equipment for example, employ ozone depleting substances (ODS) in the refrigeration system. These substances, such as CFCs and HCFCs, have a huge global warming potential, as shown in Table 2. It must be mentioned that particularly the older devices are those which contain ODS with a high global warming impact; the newer devices use alternative substances. As a consequence it is important to ensure accidental release to the atmosphere because of damages during collection or improper recycling treatment is not taking place. It is in this manner that high environmental impact during end-of-life can be avoided.

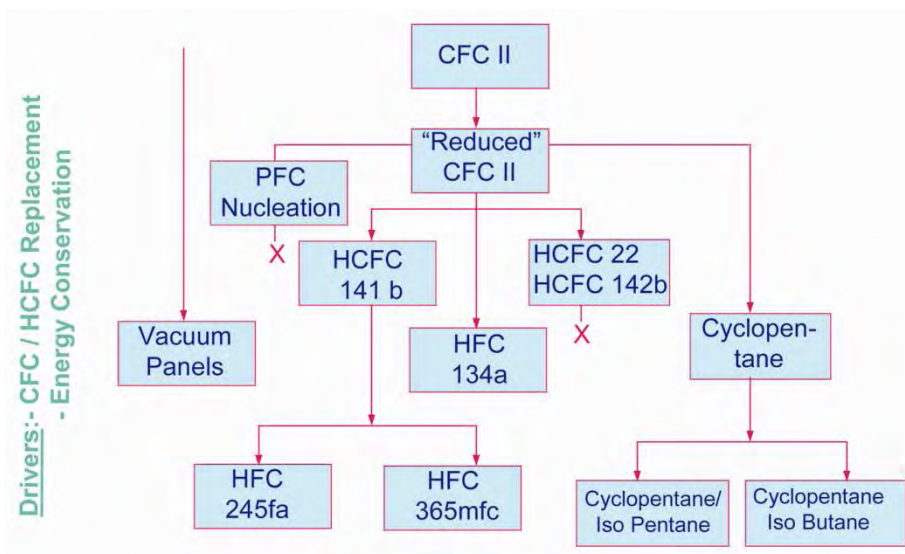

Figure 4: Use of ODS in cooling and freezing appliances over the years [24]

Substances	GWP		
CFC-12	10 720	±	3 750
CFC-114	9 880	±	3 460
CFC-115	7 250	±	2 540
CFC-113	6 030	±	2 110
CFC-11	6 800	±	1 640
HCFC-142b	2 270	±	800
HCFC-22	1 780	±	620
HCFC-141b	713	±	250
Halon-1301	7 030	±	2 460
Halon-1211	1 860	±	650
Halon-2402	1 620	±	570

Table 2: Global Warming Potential of refrigerants⁴

⁴ www.igsd.org/docs/Ozone_and_Climate_FINAL.ppt

On a more local level, uncontrolled discarding or inappropriate waste management/recycling generates significant hazardous emissions, with severe impacts on health and environment. In this context, three levels of toxic emissions have to be distinguished:

- Primary emissions: Hazardous substances that are contained in e-waste (e.g. lead⁵, mercury, arsenic, polychlorinated biphenyls (PCBs), fluorinated cooling fluids etc.),
- Secondary emissions: Hazardous reaction products of e-waste substances as a result of improper treatment (e.g. dioxins or furans formed by incineration/inappropriate smelting of plastics with halogenated flame retardants),
- Tertiary emissions: Hazardous substances or reagents that are used during recycling (e.g. cyanide or other leaching agents, mercury for gold amalgamation) and that are released because of inappropriate handling and treatment.

It needs to be understood that legislative approaches to restrict the use of hazardous substances (e.g. European Union's Directive 2002/95/EC on the restriction of the use of certain hazardous substances in electrical and electronic equipment RoHS [4]) can address only primary emissions and partly secondary emissions. However, even the "cleanest/greenest" products cannot prevent tertiary emissions if inappropriate recycling technologies are used. The latter is the biggest challenge in particular in developing and transition countries, where "backyard recycling" with open sky incineration, cyanide leaching, "cooking" of circuit boards etc. lead to dramatic effects on health and environment [5], [6], [7], [8] [20].

2.2 Structure and main steps in the recycling chain

The recycling chain for e-waste consists of three main subsequent steps: i) collection, ii) sorting/dismantling and pre-processing (incl. sorting, dismantling, mechanical treatment) and iii) end-processing (incl. refining and disposal) (Figure 5). Usually for each of these steps specialized operators/plants exist. The efficiency of the entire recycling chain depends on the efficiency of each step and on how well the interfaces between these interdependent steps are managed. If for example, for a certain device/metal the efficiency of collection is 50%, the combined dismantling pre-processing efficiency is 70% and the materials recovery efficiency 95% (which all are rather optimistic assumptions), the resulting net metal yield along the chain would be only 33%.

⁵ Although there is a ban on lead in solders (RoHS directive) recyclers have to be able to deal with lead present in End-of-Life devices that were manufactured prior to the ban on lead. An efficient recycling of lead is important from a resource perspective as well. The presence of lead does not automatically mean it will be emitted. This is only the case when it is not properly treated.

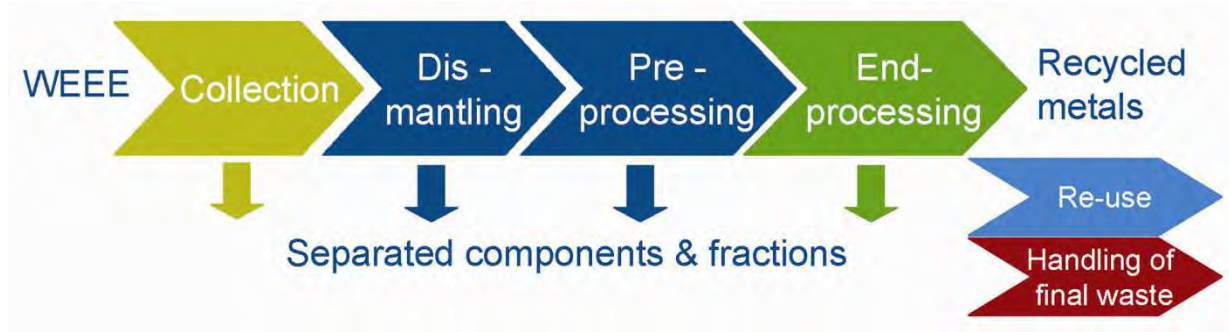

Figure 5: Recycling chain

Collection of e-waste is of crucial importance as this determines the amount of material that is actually available for recovery. Many collection programmes are in place but their efficiency varies from place to place and also depends on the device [18], [19], [21], [22]. Improvement of collection rates depends more on social and societal factors than on collection methods as such, but should be considered when discussing innovative recycling technologies/systems. When no devices are collected, the feed material to dismantling, pre-processing and end-processing facilities is lacking and a recycling chain cannot be established. The collected equipment is sorted and then enters a pre-treatment step.

The aim of **dismantling and pre-processing** is to liberate the materials and direct them to adequate subsequent final treatment processes. Hazardous substances have to be removed and stored or treated safely while valuable components/materials need to be taken out for reuse or to be directed to efficient recovery processes. This includes removal of batteries, capacitors etc. prior to further (mechanical) pre-treatment. The batteries from the devices can be sent to dedicated facilities for the recovery of cobalt, nickel and copper.

For devices containing ODS such as refrigerators and air-conditioners, the de-gassing step is crucial in the pre-processing stage as the refrigerants used (CFC or HCFC in older models) need to be removed carefully to avoid air-emissions [24]. For CRT containing appliances (e.g. monitors and TVs) coatings in the panel glass are usually removed as well before end-processing [32]. LCD monitors with mercury-containing backlights need special care too, as the backlights need to be carefully removed before further treatment.

The circuit boards present in ICT equipment and televisions contain most of the precious and special metals as well as lead (solders) and flame retardant containing resins. They can be removed from the devices by manual dismantling, mechanical treatment (shredding and sorting) or a combination of both. Manual removal of the circuit boards from telecommunication and information technologies (IT) equipment prior to shredding will prevent losses of precious and special metals and offers advantages, especially in developing and transition countries with rather low labour costs. Intensive mechanical pre-processing such as shredding and automated sorting to remove circuit boards should be avoided, because significant losses of precious and special metals can occur. One of the causes is unintended co-separation of trace elements such as precious metals with major fractions such as ferrous, aluminium or plastics due to incomplete liberation of the complex

materials⁶ [12], [13], [14]. An intermediate approach to the removal of hazardous and valuable components can be a very coarse crushing to liberate the components (circuit boards, batteries etc.) as a whole followed by removal of the components by hand picking.

It has to be noted that pre-processing of e-waste is not always necessary. Small, highly complex electronic devices such as mobile phones, MP3 players etc. can (after removal of the battery) also be treated directly by an end-processor to recover the metals.

After removal of the hazardous and other special components described above, the remainder of the ICT, cooling or television devices can be further separated in the material output streams by manual dismantling or mechanical shredding and (automated) sorting techniques. Fractions are usually iron, aluminium, copper, plastic etc. It is of utmost importance that the generated output streams meet the quality requirements of the feed materials for the end-processors. A mismatch between the two can lead to the creation of difficult or non-recyclable fractions. Well-known examples are the limits on copper content in fractions for iron/steel recycling, or the limits on iron, nickel and chromium content in aluminium fractions [15]. Furthermore, a quality mismatch can lead to the loss of material resources. For example, aluminium would not be recovered during end-processing when mixed with an iron/steel fraction or with a printed wiring board fraction, iron/steel is not recovered during aluminium recycling, and copper/precious metals are not recovered during iron/steel recycling. The challenge is to define the right priorities and find a balance in metals recovery that considers economic and environmental impacts instead of only trying to maximize weight based recovery rates, regardless of the substances involved. Another aspect could be the mismatch in physical aspects of the materials, such as particle size. One could think of shredded e-waste material while the smelters can easily take unshredded material.

The **final metals recovery** from output fractions after pre-treatment takes place at three main destinations. Ferrous fractions are directed to steel plants for recovery of iron, aluminium fractions are going to aluminium smelters, while copper/lead fractions, circuit boards and other precious metals containing fractions are going to e.g. integrated metal smelters, which recover precious metals, copper and other non-ferrous metals, while isolating the hazardous substances.

Both ferrous and non-ferrous smelters need to have state-of-the-art off-gas treatment in place to deal with the organic components present in the scrap in the form of paint layers and plastic particles or resins containing flame retardants. During smelting formation of volatile organic compounds (VOCs), dioxins can appear and their formation and emission have to be prevented. Alternatively, painted scrap, such as painted aluminium can be delacquered prior to smelting using appropriate technologies [16] with off-gas control equipment.

For treatment of circuit boards, it is of utmost importance that the smelter is equipped with state-of-the-art off-gas treatment equipment, since otherwise dioxins will be formed and

⁶ After shredding of circuit boards the resulting particles still are small aggregates of e.g. ferrous parts, plastics, non-ferrous metals etc, there cannot be a complete liberation without creating excessive volumes of dust. Sorting these particles based on magnetic, density or conductivity properties can only have a limited selectivity and leads to mixed, impure output fractions. When trace (precious) metals are associated with the ‘wrong’ output fraction they will not be recovered in the subsequent smelting processes. For example, precious metals in the plastic, ferrous or aluminium stream are lost, while they can be recovered when found in the copper or circuit board stream. Another cause is the losses to dust and fine particles. The mechanical impact by shredding generates fine particles of ceramic components, which contain precious metals, such as ceramic capacitors (containing Pd, Ag) or ICs (Au). This dust with organics as a main constituent then either is just dispersed, is caught by a dust extractor, or is partly spread over various output fractions by adhesion. Particularly for precious metals in printed wiring boards the losses can be considerable (see [12]).

emitted. Standard copper smelters or hydrometallurgical (leaching) plants however, are not advisable for circuit board treatment due to inadequate handling of toxic substances (such as lead, cadmium or organics) and lower metal yields. In hydrometallurgical plants the special handling and disposal requirements necessary for the strongly acidic leaching effluents (e.g. cyanide, nitric acid, aqua regia) have to be diligently followed to ensure environmentally sound operations and to prevent tertiary emissions of hazardous substances. On the other hand, pure metallic copper/precious metal fractions without organics can also be treated in copper smelters or modern hydrometallurgical plants (leaching).

Structuring of the recycling chain

Whereas investments and technology requirements are less challenging in collection and dismantling, mechanical pre-processing and especially metallurgical metals recovery requires considerable investments in advanced technologies to handle the heterogeneous and complex materials. As a consequence an international division of labour has been established over time. Collection, dismantling and partly mechanical pre-processing takes place at a national or regional level, as does metals recovery from less complex materials/fractions such as ferrous, copper and aluminium. On the contrary treatment of complex materials such as circuit boards, batteries, cell phones in integrated metal smelters or specialized battery recycling plants takes place in a global context⁷. These smelters fully employ the possibilities of non-ferrous extractive metallurgy to unravel the complex materials into its constituent metals. The interactions and links between the major and minor metals used in these processes, as well as the impact of the impurities are summarized in the Metal Wheel developed by Reuter et al. [15]. Such plants require an appropriate tonnage and feed mix with other non-e-waste materials, a high-tech flow sheet and infrastructure, a highly skilled workforce, as well as investments of several EUR 100 million. In this sense it is not financially or economically feasible to replicate such installations in every country. Chapter 3.1.2 gives an example of how metals are recovered in an integrated smelter. Since the complex fractions that need to be treated in such operations only account for a very minor part of the mass of e-waste, and because the (ocean) transport of e.g. a container of computer circuit boards neither implies high costs nor environmental burden, it is advisable to benefit from such specialization and economies of scale. In an optimal set-up it leads to a much better overall economic viability and environmental performance than a multitude of “autarkic” island solutions can achieve. In this context it has to be understood that the recycling of complex electronic devices is as challenging as their manufacturing and consequently also benefits from a division of labour as it is daily practice in electronics manufacturing.

As mentioned before, the single steps in the recycling chain are closely interlinked in both an upstream and downstream direction. Furthermore, the recycling chain itself is linked to other steps in the product life cycle such as the product design, manufacturing and product use. What is done in dismantling and pre-processing affects the subsequent steps of material recovery, while technological advances in final materials/metals recovery might imply new requirements for the output fractions of preceding steps. New material compositions, combinations or connections in electrical and electronic equipment (e.g. LCD or plasma monitors) can imply adjustments to the set-up of the recycling chain.

⁷ Such integrated metal smelters equipped with appropriate installations for off-gas and effluent treatment are currently located in Belgium, Canada, Germany, Japan and Sweden. They source their feed materials from all over the world. The feed mix comprises besides circuit boards and copper/precious metals containing e-waste-fractions also mining concentrates, smelter residues, catalysts etc.

A close interaction and communication among the participants/stakeholders in the recycling chain is thus crucial to achieve a good overall efficiency and to be able to anticipate future developments. Moreover, transparency, accuracy and verification of the actual flows of materials along the recycling chain are important for all stakeholders. Authorities and manufacturers need certainty about the actual performance of the involved recycling operations (in achieving resource efficiency and environmental compliance), so that the legal or producer responsibility obligations of authorities and manufacturers are fulfilled.

2.3 Objectives of e-waste recycling and basic considerations for innovation

Following-up directly from the previous chapters the main objectives to achieve are:

- Take care of hazardous/toxic substances contained in e-waste in an environmentally sound manner while preventing secondary and tertiary emissions,
- Recover valuable materials as effectively as possible,
- Create economically and environmentally sustainable businesses (optimize eco-efficiency),
- Consider the social implications and the local context of operations (e.g. employment opportunities, available skills and education etc.).

Taking the above objectives into consideration, the identification of innovative technologies needs to be based upon an evaluation to what extent a specific technology contributes to achieving these objectives as a whole, also taking into account the regional context and the step in the recycling chain it addresses. A technology cannot be considered sufficiently innovative when it is very clean with respect to emissions, but inefficient in recovering valuable materials or too costly to be applicable in practice, for example. The same applies if a process (chain) would recover valuable substances at attractive costs but fails to prove that hazardous emissions do not occur. And finally, innovative technologies have to take the regional context into account. What could be a highly effective technology/solution in e.g. a Western European (highly industrialized) context can be a completely misguided approach in Africa or Asia (developing, industrializing context) – and vice versa. Implementing a high-tech, capital intensive recycling process will not be suitable in every country or region, and hence cannot be regarded as innovative per se. In another region/country with the required (framework) conditions, the same technology would be very suitable and can be regarded as highly innovative. In this respect an innovative approach goes beyond the technology aspect but must include a most appropriate combination of processes in a recycling chain. This combination of processes is not limited to a single country/region, but should be seen from an international/global perspective. In this manner the most suitable technologies for the different stages in the recycling chain can be combined in an optimum way, while utilizing specific framework conditions in each location.

Criteria to compare the innovation of technologies can be grouped along the elements of sustainability. The following list is not exhaustive and can be further elaborated:

- Environment, health and safety: emission levels into air, water and soil; energy efficiency; use of water, land and raw materials; process security/risk of toxic exposure due to process failures; workers protection; final fate of (by)-products; infrastructure in place etc.
- Resource recovery/technology: variety of substances that are recovered; recovery and yield for individual materials; rating of recovered materials with respect to economic and environmental value; technology used; interfaces to other steps in the

chain; requirements of the next processing step and also requirements to preceding step; etc.

- Economic viability: process costs; impact on process costs (and yields) of preceding and subsequent steps in the recycling chain; quality and market value of output streams; process stability/vulnerability to changes in feed composition; labour cost; availability of skilled/trained labour, capital access; investment security; intellectual property security; critical size/economies of scale; available markets for output fractions; availability and sources of feed material; infrastructure in place; etc.
- Social compliance: impact on employment and public wealth; current recycling infrastructure; involvement of existing informal structures; legislative framework; etc.

2.4 Innovation criteria for evaluation of technologies

Innovation in e-waste treatment should focus on the major needs to improve overall sustainability. The general objectives of e-waste recycling as well as the separation criteria for e-waste should be met. In this context often the largest impact would derive from improvements in collection, dismantling/pre-treatment and handling of hazardous streams, as well as in interface management along the (global) recycling chain, since currently the biggest deficits occur here. Unfortunately, this is often not the case and much (research) efforts are spent in "reinventing the wheel", e.g. in developing new technologies for metals recovery from circuit boards, instead of making progress in the above mentioned areas where it is really necessary.

Conversion of the general criteria to specific requirements for separation and dismantling of e-waste are given in Table 3.

	Desired treatment/ action
1. Separate before treatment	
a) Toxic/hazardous materials	
Cooling fluids and foam	Controlled removal and disposal
Mercury backlights	Controlled depot
PCB capacitors	Controlled depot
Batteries	Sort and process in specialized plants
b) High value materials	
Reusable components	Refurbish and sell
Circuit boards (high and medium grade)	Process in integrated non-ferrous/copper smelters
Circuit boards (low grade)	Upgrade (manually) and process in integrated smelters
2. Dismantle, liberate, sort	
Clean plastics	Process further with appropriate technologies
(CRT) glass	Process further with appropriate technologies; glass to glass producer, CRT glass to CRT glass producer or lead smelter.
Ferrous metals	To integrated steelmaking facility or to steel scrap remelter (electric arc furnace)
Non-ferrous metals Al, Mg	To secondary aluminium or magnesium remelter or other appropriate technology*.
Non-ferrous metals Cu, Pb, Sn, Ni, PM	Process further with appropriate technologies
Others	Process further with appropriate technologies

* Low quality scrap can also be used in steelmaking as a reducing agent (feedstock recycling)

Table 3: Separation and dismantling criteria for e-waste

The sustainability attributes used as innovation criteria and to compare current and innovative technologies were adapted according to Zumbühl 2006 [31] and are given in Table 4 below. The term “technology” summarizes all technical installations, skills, processes and combinations thereof as defined in chapter 1.

Attributes	Indicators involved
Economic attributes	
Low net costs	Costs for transport, processing and labour vs. revenues
Low capital costs	Investment costs for additional plants and technologies used in a scenario
Increased potential for local economic growth	Additional industries and services involved by implementing a scenario
Environmental attributes	
Low use of electricity	Savings of electricity but also energy in general by implementing a scenario
Low fuel use for transport	Fuel used by shipping and road transport
Low use of freshwater	Freshwater consumption of a recycling scenario
Little (toxic) emissions	Caused vs. prevented emissions according to the savings of raw materials calculated with eco-indicator '99 (or other appropriate tools)
High metal recovery rates	Range and yields of metals contained in the waste, which can be recovered and used as secondary raw material. In case of technical conflicts prioritization by economic <u>and</u> environmental value ("footprint") of the recovered substances.
Social attributes	
Creation of jobs for the previously unemployed	Working hours for low-skilled and semi-skilled workers generated
Creation of highly skilled jobs	Working hours for highly skilled workers generated
Creation of jobs outside the target country	Working hours generated outside the target country
Low health and safety impacts	Impacts of a scenario on health and safety of the employees engaged in a scenario

Table 4: Sustainability attributes used as innovation criteria and to compare current and innovative technologies

These attributes in principal are valid for all the different steps in the recycling chain. Nevertheless, there are points for attention when making the evaluation. When looking at a recycling chain, only different technologies within the same stage of the chain can be compared to each other, as the objectives for the technologies are then the same.

Furthermore, the attributes are not independent parameters. They are partly connected to each other, as it is impossible to achieve the maximum value for each single attribute. Instead a compromise has to be found where for the entire system the optimum value is obtained. For example, a high metal recovery and/or low toxic emissions from complex materials cannot be achieved at the lowest operating level or with the lowest capital costs. This also leads to a quantitative interpretation of "high", "low" etc. as stated in the table. Practically, there might be a useful value for "low", but this is relative and depends on the process looked upon. For example, low capital costs for end-processing will often still seem high compared to the capital cost for pre-processing.

To make an evaluation of the degree of innovation of technologies, a prioritization or ranking of the attributes is necessary, depending on the selected objectives and the frame conditions present. This prioritization is not achieved using a mathematical formula with standard weighing factors. It needs rather a comprehensive evaluation on a case-by-case

basis, which is based on a profound understanding of the specific frame conditions as well as expert knowledge of the technologies involved and how the technology is tied into the larger picture. Using the prioritization it becomes clear how and which trade-offs can be made while keeping all attributes included in the evaluation. However, no trade-offs should be made with respect to toxic emissions into the environment.

3 Markets for recycling technology

3.1 Innovative e-waste recycling technologies

According to chapter 2.2 the e-waste recycling chain could be divided into three main subsequent steps – i) collection, ii) dismantling and pre-processing and iii) end-processing for final metal recovery. Technology plays a crucial role especially in the second and third steps and, in particular, in pre-processing and end-processing. After the collection phase end-of-life appliances are treated in order to obtain components (to be reused or refurbished) or materials fractions (to be recycled and reused as raw materials). Components or material fractions that are not reused or recycled (due to their intrinsic hazardous content or lack of secondary markets) are sent to a suitable disposal site. Notwithstanding different approaches and methods the aim of second and third step of the recycling chain is mainly to:

- Take care of hazardous components and fractions in an environmentally sound manner,
- Economically recover components and material fractions.

The two dimensions are inter-linked by means of eco-efficiency, intended as the effort of obtaining attractive economic results (revenues and costs) without compromising the environment. Any approach has furthermore different social implications so that a full, in-depth assessment needs to be carried out before the optimal solution in different contexts can be identified. Depending on 1) the type of equipment and treatment technologies available, 2) the socio-economic boundary conditions and 3) the legislative requirements to be fulfilled, different options that can ensure the full treatment of e-waste exist.

In the following sections technologies available for dismantling and pre-processing of e-waste are presented, according to the different end-of-life device streams:

- C&F appliances,
- ICT equipment,
- Monitors and TVs.

While collection, dismantling and pre-processing can differ across different e-waste streams, depending on the constituent components or materials as well as on the technologies available, end-processing technologies have been developed with a focus on the material streams, regardless of the e-waste device stream they come from.

End-processing technologies are described in the following according to those main fractions streams, having (i) environmental (toxic control, resource conservation, energy saving) or (ii) economical relevance or (iii) a relevant mass percentage on the total weight of appliances, as extensively detailed in the UNU study supporting the 2008 Review of the WEEE Directive [18]:

- PWBs and small electronic devices: due to the environmental and economic value connected with special and precious metals used in such devices,
- Metallic fractions with precious metals: for the reasons above,
- Metallic fractions without precious metals: for the economic value and the mass relevance of such fractions in some e-waste categories, like C&F appliances,
- Aluminium: Both for economical reasons as well as environmental ones, mainly connected with the energy usage to make primary aluminium,

- Ferrous metals: For economic reasons and for the mass relevance in Cooling and freezing appliances, as well as environmental aspects connected with the production of the primary ones, in particular the CO₂ production,
- Glass (specifically CRT glass): For environmental reasons, mainly connected to the use of lead.

3.1.1 Pre-processing technologies

3.1.1.1 Cooling and freezing appliances

The recycling chain for C&F appliances starts with a collection phase in which a critical environmental issue needs to be highlighted. Notwithstanding the clear environmental benefits in maximizing the amount collected it is crucial to avoid damaging the refrigeration circuit during transport and handling in order to prevent losses of ODS (mainly CFC and HCFC) with a huge GWP (see Table 2) used in older appliances [24]).

The circuit contains on average 100 g of gas; it represents roughly 25% of the total amount per unit, while the remaining part is used as blowing agents in foam and Polyurethane (PUR).

Dismantling activities mainly aim at removal of the hazardous fractions (de-gassing of circuits) and hazardous components. De-gassing activities are carried out semi-automatically, by piercing the base of the compressor with a proprietary de-gassing unit and extracting refrigerant and oil, or by so-called “nipping” of the cooling circuit. The refrigerant is extracted and afterwards the oil is pumped out by placing a tube to the base of the compressor via the stem of the cooling circuit. Up to 50 units per hour can be processed when more than one refrigerator is being de-gassed simultaneously on the same line.

In the following pre-processing activities the recovery of valuable components could be done by manual dismantling, especially where second hand markets for refurbished parts exist.

On the other hand, fully automated lines for shredding and separation of material fractions exist; shredders/fragmentizers are long-established processes for treating general ferrous metal. They normally process a mixture of end-of-life items. The fragmentizer shreds the material to less than 150 mm in size, and the shredded material is fed to separators, which separate the material into fractions. In the case of C&F appliances, the trituration needs to be carried out in a sealed container with nitrogen injected to prevent possible explosions and to compress the CFC contained in the PUR foam. Removal and containment of the nitrogen and PUR dust after shredding needs to be done to avoid emissions to the environment. Established technologies can treat up to 80 units per hour.

Separation of shredded fractions can then be done both manually or using different technologies developed over the years. Depending on specific streams (ferrous, non-ferrous, non-metals) and properties of materials the available technologies include: magnetic belts and eddy current separators which are most used, but also magnetic induction, vibration or other physical properties of the materials could be used to identify and separate the desired fractions. Fully automated shredding and sorting plants need an investment of EUR 2-4 million for a standard line and currently rely on incoming flows of appliances of 3,000-6,000 tons per year.

Objectives		How to achieve
HZ	De-gassing CFC, HCFC	Automatic units [23], [24]: Removal of coolant and oil in the same step with a proprietary de-gassing unit Removal of coolant and oil in separate stages
HZ	Removal mercury-containing switchers and PCB capacitors	Manual dismantling
HZ+R	Removal compressor (R) and oil (HZ)	Manual dismantling Residual of CFC in oil to be separated
R	Recovery of (valuable) components [25]: Compressors, doors, electric parts, glass shelf, salad crisper, relay, bulb	Manual dismantling
HZ+R	Recovery of material fractions: Ferrous Non-ferrous (Al, Cu) Non-metals CFC/HCFC in foams Plastics, rubber Woods Remaining fractions (PUR, waste)	Manual dismantling Shredding and separation [26], [27], [28], [29], [30]: Manual Magnetic belts, eddy currents, magnetic inductions, vibrations, density, dielectric properties or melting temperature

HZ = control over hazardous fractions; R = recovery of components or material

Table 5: Pre-processing technologies available in the recycling chain of cooling and freezing appliances

3.1.1.2 ICT appliances

The first step of the recycling chain of ICT equipment is simpler than for C&F appliances as during the collection step there are no special measures necessary to avoid release of hazardous substances to the environment (no CFCs present). Still it is crucial to maximize the collection of ICT equipment to ensure environmentally sound treatment and to recover valuable material resources. As ICT appliances represent a broad range of devices, dismantling and pre-processing activities are mainly focusing on:

- Removal of hazardous components like ink cartridges (where present), PCB containing capacitors, mercury containing switchers but especially batteries (NiCd, NiMH Li-ion and Li-Polymer),
- Removal and recovery of valuable or reusable components like HDs or fractions like PWBs.

The following pre-processing activities aim at separation of the main fractions having environmental (and economic) relevance (like PWBs, containing precious metals, copper, tin etc.). Fractions containing private or confidential data should be destroyed accordingly by applying shredding and flaking machines or controlled smelting processes. ICT appliances do not present critical issues with regard to occupational health and safety during the pre-processing step as long as massive exposure to dust is avoided. Consequentially, manual dismantling could be a very effective and efficient way to recover the economic and environmental value in such an e-waste stream. Furthermore, manual dismantling has a low

investment cost, utilizes simple tools and can be done by people with little or low education after appropriate training.



Figure 6: Deep-level manual dismantling of hard disks (left) and dismantling table with pneumatic tools (right)

In the pre-processing phase, manual and semi-manual dismantling can be efficient to further disassemble the components including power supply, hard discs and disc drivers. Tools like electric or pneumatic screwdrivers can be applied to accelerate the speed of dismantling (Figure 6). The benefit for carrying out manual dismantling is that the products after the disassembly can be easily grouped into different fractions in their complete and intact forms, which could reduce the separation effort in the end-processing phase and also be able to reclaim the reusable parts. For example, PCBs without any other fraction mixed in can give a higher metal yield during end-processing. A stream line assigning a specific dismantling division to different workers would greatly improve the dismantling efficiency. This approach is eco-efficiently preferable in the areas with a lower labour cost and abundant workforce.

Notwithstanding eco-efficiency in manual dismantling, pre-processing and even automated processes for treating these items based on shredding, followed by mechanical separation, have been developed. Such processes use multiple stage shredding steps to reduce the material to less than 20 mm in size. Different metal fractions are then extracted from the shredded material using a magnetic belt to remove ferrous metal followed by an eddy current separator which removes non-ferrous metal. The non-ferrous material is further separated into copper, aluminium, brass etc. using among others optical sorting, density separation, eddy current separation or vibration separation. The remaining non-metallic material is then processed in order to separate circuit boards and wire, while the other remaining fractions are land-filled. It must be emphasized that from a resource perspective it is better to recover the high-grade PCBs prior to shredding to avoid high losses of precious metals, as discussed in chapter 2.2. Furthermore, extensive shredding of PCBs and plastics can generate dust containing (brominated) flame retardants as well as dioxins within the hot shredder equipment. Exposure of the workers to these substances can be avoided by removing the PCBs before shredding and by taking adequate occupational hygiene measures [82]. Previously described fully automated plants, which shred and separate up to

5 tons of material per hour, require an investment of up to EUR 1-2 million for a standard line, currently rely on incoming flows of appliances of nearly 5,000-8,000 tons per year.

Objectives		How to achieve
HZ+R	High collection rate	
HZ	Removal of: Ink cartridges, PCB containing capacitors, Mercury-containing switchers, batteries	Manual dismantling/sorting
R	Recovery of (valuable) components: PWBs, HD, reusable components	Manual dismantling/sorting
R	Recovery of material fractions: Ferrous Non-ferrous (Al, Cu) Non-metals Plastics, rubber, woods Remaining fractions	Manual dismantling and sorting Shredding and separation: Manual sorting Magnetic belts, eddy currents, magnetic inductions, vibrations, density, dielectric properties or melting temperature
R+HZ	Recovery of Material fractions	Smelters, Integrated smelters

HZ = control over hazardous fractions; R = recovery of components or material

Table 6: Pre-processing technologies available in the recycling chain of ICT appliances

3.1.1.3 Monitors and TVs

The recycling chain for CRT containing appliances (monitors and TVs) starts with a collection phase where a critical environmental issue needs to be highlighted: notwithstanding the clear environmental benefits in maximizing the amount collected, it is crucial to avoid damaging the tube during transport and handling in order to avoid losses of the hazardous coatings on the front panel.

The following dismantling activities aim at recovering valuable components or fractions like the electron gun (containing copper) or PWBs. The pre-processing activities primarily aim at separation of different types of glass used (the funnel contains lead and other metals [33]) and removal of coatings from the front panel. Two main approaches exist:

- Manual removal of the CRT from the TV/monitor, split to separate the funnel glass from the front panel glass and manual removal of the coating from the front panel glass,
- Manual removal of the CRT from the TV/monitor, shredding and then mechanical recovery of the fractions (including the coating).

The main approach that is used is the first one, done semi-automatically. Different technologies have been developed over the years to separate the funnel from the panel glass (hot wire cutting, thermal shock, laser cutting, diamond wire/saw or water jet) as well as to remove coatings (plastic media blasting, water circulation, fluidized bed cleaning system). Such semi-automatic processes ensure a productivity of nearly 10 units per hour while the investment needed for a line is between EUR 0.1 million (second-hand system) and EUR 0.3 million (new system) [31].



Figure 7: Semi-automatic line for cutting (hot wire) of CRT and removal of coatings

Alternative processes involve shredding of the CRT and then separating the front and panel glass and recovering the coating. When the whole monitor is shredded, the glass is mechanically separated from the other material streams, such as metals, plastics, circuit board and cable. The two types of glass can be separated using a number of different techniques including density separation, sizing, ultraviolet (UV) light, visible light or X-ray fluorescence. A fully automated process for the shredding of CRT and separation of fractions has been developed by Sims Recycling Solutions [117].

In contrast to printed wiring boards from computers, monitor and TV boards usually contain massive iron and aluminium parts (cooling elements, transformers, frames) and possibly large condensers. It is recommended to remove these massive parts before sending the remaining boards to integrated smelters for final processing. Benefits of such a removal are twofold: Firstly, aluminium (Al) and iron (Fe) parts can be valorized by sending them to appropriate end-processing facilities (see 3.1.2.4), while they cannot be recovered as metals at integrated precious metal smelters. Secondly, the PWBs freed from these massive parts are relatively upgraded in their copper (Cu) and precious metals content, which will generate better net revenues obtained from the smelters. Where labour costs allow, manual removal of the massive parts is advantageous due to its good selectivity. If mechanical removal takes place, e.g. by shredding and sorting, special attention should be put on not losing precious metals into the Al or Fe fraction.

Objectives		How to achieve
HZ	Removal of CRT	Manual dismantling
R	Recovery of valuable components or materials: electron gun, printed wiring board (PWBs)	Manual dismantling/sorting PWBs: subsequent (manual) removal of large aluminium and iron parts recommended
HZ	Recovery of coatings and lead containing glass	Manual or semi-automatic split of CRT [32] (hot wire cutting [33], thermal shock, laser cutting, diamond wire, diamond saw, water jet [35]) to separate the funnel glass from the front panel glass Manual or (semi)-automatic removal of coating from the front panel glass (Plastic Media Blasting, Water Circulation, Fluidized Bed Cleaning System) Automatic shredding of CRT and recovery the material fractions (including the coating)
R	Recovery of materials	Manual sorting of front panel glass (max 4% Pb) and funnel and neck glass (22-30% Pb) [83] Automatic sorting: The two types of glass can be separated using a number of different techniques including density separation, sizing, UV light, visible light or X-ray fluorescence

HZ = control over hazardous fractions; R = recovery of components or material

Table 7: Pre-processing technologies available in the recycling chain of cooling and freezing appliances

3.1.1.4 Evaluation of pre-processing technologies

In Table 8 a detailed analysis of the pre-processing technologies is given. For all waste streams positive benefits exist in manual disassembly and sorting, as well as for the introduction of semi-automatic technologies aiming at fulfilling specific and environmentally relevant activities (De-gassing of CFC, HCFC; CRT cut & cleaning).

Notwithstanding different approaches and levels of innovativeness in technologies, boundaries conditions and in particular social attributes (e.g. job creations), or economic ones (e.g. like capital intensiveness) which play the most crucial role and could hamper the effectiveness of any technology or approach.

Fully automated technologies are less innovative and suitable for developing countries for pre-processing activities, especially when considering the inter-linkages with end-processing technologies described in the following chapters as well as the global recycling chain and material flows.

	Waste streams	Economic attributes	Environmental attributes	Social attributes	Innovative technology*
Manual dismantling/ sorting of fractions	All	Low capital cost, sorting of valuable fractions/ components	Efficient sorting of fractions	Labour intensive, Job creation	Yes
De-gassing CFC, HCFC	Cooling and freezing	Mandatory requirement having low cost	Fundamental step to ensure control over hazardous substances having huge GWP potential	Job creation	Yes
Semi-automatic CRT cut and cleaning	CRT	Low capital and net cost	Low energy consumption	Labour intensive	Yes
Automatic shredding CRT	CRT	High capital cost	Higher energy consumption	Low job creation	No
Automatic Shredding and separation	All	High capital costs	Higher energy consumption	Low job creation	No, Feasible for specific activities
Automatic shredding and recovery CFC foam	Cooling and freezing	High capital costs	Higher energy consumption, Sealed container for titration	Low job creation	No

* For interpretation of the meaning of innovative technology in a recycling chain context see chapter 2.4

Table 8: Identification of innovative pre-processing technologies for developing countries in the e-waste recycling chain

3.1.2 End-processing technologies

For the end-processing of the material fractions from ICT, C&F and CRT appliances a distinction has to be made between different material streams. Each material stream has a specific set of technologies that can be used to recover the metals. The unit operations or equipments (often proprietary or patented) that are combined into highly effective end-processing flow sheets, can be roughly grouped into:

- Pyrometallurgy, which use high temperatures to chemically convert the feed materials and separate metals and impurities into different phases so valuable metals can be recovered. The high temperatures in the furnace or smelter are generated via the combustion of fuel or via electrical heating. Examples of technical hardware are submerged lance smelters, converters, rotary furnaces, electric arc furnaces etc.,
- Hydrometallurgy, which use strong acidic or caustic watery solutions to selectively dissolve and precipitate metals e.g. leaching, cementation, solvent extraction etc.,

- Electro-metallurgy, which use electrical current to recover metals, e.g. electro-winning and electro-refining of copper, zinc etc.

A comprehensive overview of equipment and flow sheet combinations is given in [78][79][80]. A combination of unit operations from the different groups is often necessary to achieve optimal and efficient metal recovery. Biometallurgical methods using bacteria or fungi are in a research stage only and are currently not applied in the e-waste recycling chain [37]. Hence, these methods will not be discussed here.

The technologies discussed in the following sections are state-of-the-art, best available technologies that are currently used in the recycling industry.

3.1.2.1 Printed wiring boards and small electronic devices

The combination of many different metals in PWBs and small electronic devices (Figure 1), together with organic resins/compounds requires processes that can effectively recover most of the metals from these complex materials and deal with toxic/hazardous substances simultaneously in an environmentally sound manner. Typically, a PWB from a PC can contain 7% Fe, 5% Al, 20% Cu, 1.5% Pb, 1% Ni, 3% Sn and 25% organic compounds (loss of ignition - LOI), together with (in parts per million - ppm) 250 Au, 1000 Ag and 100 Pd. Furthermore traces of As, Sb, Ba, Br and Bi are present [13].

Printed wiring boards or PWBs-containing fractions, ICs, processors, connectors and small electronic devices (e.g. mobile phones and MP3 players after removal of the battery) can be directly treated in integrated copper and precious metal smelter-refinery operations, without further size reduction of the material. The PWBs and small devices are mixed with other precious metal containing materials such as catalysts, by-products from the non-ferrous industries or primary ores. Typically an integrated operation starts with a pyrometallurgy step: the PWBs and small devices are smelted together with other materials in a furnace or smelter at high temperatures to separate the valuable metals, while the organic compounds are converted to energy. Thereafter, different pyrometallurgy, hydrometallurgy and electrometallurgy unit operations are used in the most appropriate/adequate combination to deliver an optimal recovery of materials. An example is shown in Figure 8.

Particularly important is the presence of a suitable extensive off-gas cleaning system connected to the furnace or smelter that can deal with or prevent the formation of VOCs, dioxins and acid gases originating from the organic substances in the feed material, as well as any generated dust. A number of technologies are available for destruction or capture of dioxins, furans and other gases, such as adiabatic coolers, scrubbers, filters and catalytic decomposition are used in combination for optimal performance [84][85]. Formation of dioxins during smelting can be prevented by good control of the process conditions: sufficiently high temperatures and long residence time in the smelter (above 1000°C for 1 second, above 850°C for 2 seconds), complete combustion, constant process conditions via automated control and rapid cooling of the off-gas to below 180-250°C [85]. Heat is recovered from the off-gas for use in subsequent processes using the generated heat in the most efficient way as possible.

Due to the complex nature of the feed material, sophisticated flow sheets and sufficient economies of scale are crucial for integrated smelting and refining. Such facilities exist in Belgium, Canada, Germany, Japan and Sweden [36][86][87], and shipments of PWBs and other appropriate fractions are sourced from a global supplier base. As an example the integrated smelting and refining operations of Umicore Precious Metal Refining, Belgium is shortly described.

This integrated smelter and refinery recovers and supplies back to the market 17 metals (Au, Ag, Pd, Pt, Rh, Ir, Ru, Cu, Pb, Ni, Sn, Bi, In, Se, Te, Sb, As). About 25% of the annual production of Ag and Au and 65% of Pd and Pt originates from end-of-life recyclables (e-waste materials plus catalysts). The e-waste fractions are mixed with other complex precious metals bearing materials such as automotive and petrochemical catalysts, industrial wastes and by-products from the non-ferrous industries. In total over 200 different types of raw materials, up to 350,000 tons, are processed each year.

The integrated smelter-refinery has two main routes: the precious metals operations and the base metals operations (Figure 8). For most of the e-waste materials, the smelter is the first step. The smelter uses IsaSmelt submerged lance combustion technology [81] and is equipped with extensive off-gas emission control installation and processes about 1,000 tons of feed material per day. At about 1200°C enriched air and fuel are injected through a lance in a liquid bath and coke is added for chemical reduction of the metals. Organic components from the circuit boards function as an additional reducing agent and fuel, thus being classified as feed stock recycling [36]. Blowing air and fuel into the bath ensures rapid chemical reactions and good mixing as the solid feed material, the copper metal phase and the lead slag phase are stirred vigorously. The precious metals dissolve in the copper, while most other (special) metals are concentrated in the lead slag together with oxide compounds such as silica and alumina. After smelting the copper goes to the leach-electrowinning plant and the lead slag goes to the blast furnace.

At the leach-electrowinning plant, which combines hydro- and electrometallurgy, the granulated copper is dissolved with sulfuric acid resulting in a copper sulfate (CuSO_4) solution and the precious metals are concentrated residue. In the leach residue the precious metals content is 10x higher than in the copper feed material. The CuSO_4 solution is sent to the electrowinning plant for recovery of the copper as 99.99% pure cathodes. The remaining acid is returned to the dissolution step. The precious metals residue is further refined at the precious metals refinery. All possible variations and ratios of Ag, Au and platinum group metals (PGMs) are recovered one by one as high purity metals (> 99.9% pure), using well-established pyro- and hydrometallurgical methods combined with unique in-house developed processes.

The lead oxide slag from the smelter, containing Pb, Bi, Sn, Ni, In, Se, Sb, As and some Cu and precious metals, is further treated in the lead blast furnace together with Pb-containing raw materials. The furnace produces about 200-250 t/day of lead bullion (95% Pb) in which special metals and silver are collected. Besides bullion the blast furnace produces copper matte (returned to the smelter), nickel speiss (sent to the nickel refinery and any precious metals sent to the precious metal refinery) and slag, which is sold as a construction material/additive for concrete. Refining of the bullion in the lead refinery, yields - besides Pb - Bi, As, Sn, Sb and two residues. The silver-residue is further treated in the precious metals refinery. The indium-tellurium residue is further treated in the special metals refinery together with the selenium-residue from the precious metals refinery.

The integrated process achieves high precious metal recoveries from complex e-waste materials. A gold recovery of over 95% has been reported [36]. Independent of the route the precious and special metals take through the flow sheet and in the end they are all separated from the carrier metal and recovered while substances of concern are converted into useful products (Pb, Sb, As) or captured and immobilized in an environmentally sound manner (Hg, Be, Cd). As also the produced slag is a certified building material, the integrated smelter process converts less than 5% of its feed materials mix into a waste fraction that is sent to controlled deposits; for e-scrap the final waste is even much lower [36].

It must be noted that also primary copper smelters, which are present in transition countries (China, India, South Africa), could be “upgraded” to treat materials with high organic compound content, like the PWBs and small devices, by installing suitable off-gas treatment equipment and taking additional environmental protection measures. However, this would require considerable investments in equipment and know-how and a thorough monitoring of the operation. Without such measures in off-gas treatment, waste water management and proven performance records pyrometallurgical operations are not appropriate to treat circuit boards or similar e-waste fractions that contain halogenated organics.

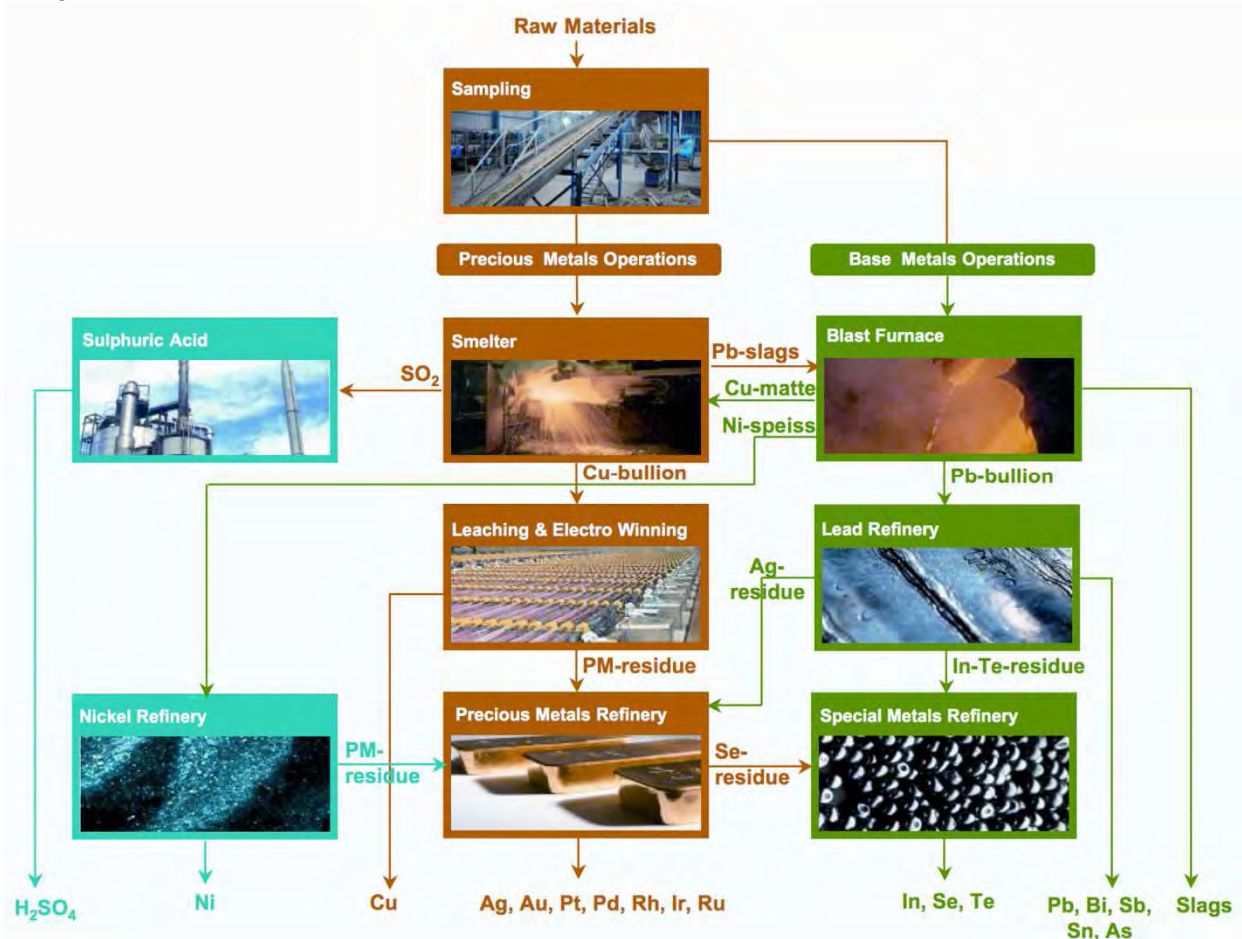

Figure 8: Umicore integrated smelting/refining operations*

*Smelter, blast furnace, lead refinery use pyrometallurgy unit operations; leaching, special metals and nickel refinery use hydrometallurgy unit operations and the precious metal refinery uses both hydro- and pyrometallurgy unit operations

Alternative recovery methods of (precious) metals from printed circuit boards have been discussed in a substantial number of research papers [37] in the past years. These alternatives have to be evaluated using the entire range of characteristics for environmentally sound, sustainable processes that are also used to evaluate the current state-of-the-art processes. Such an evaluation must include proven compliance with environmental standards, final destination/processing of waste and by-products, as well as mass balances to evaluate resource efficiency/effectiveness. Results obtained on a lab scale cannot be

considered sufficiently as workable unless they can be confirmed by practical experience in large scale, “real life” installations.

Investigated alternative flow sheets use predominantly or only hydrometallurgical and electrometallurgical unit operations as these are presented as cheap (lower investment cost), relatively easy to implement and low environmental impact operations. Others however argue that hydrometallurgical and electrolysis processes produce large quantities of waste acid liquid, which needs to be disposed of in a proper manner [88]. Based on a literature review, which found only laboratory-scale hydrometallurgical processes for PWBs, there are several points that have to be considered when looking at hydrometallurgical treatment of printed wiring boards:

- The material complexity of the circuit boards highly complicates the hydrometallurgical processes. Interactions during leaching reduce the effectiveness of metal recovery, require additional processing steps and difficulties to treat intermediates might be created. It has been reported that direct leaching with aqua regia - nitric acid (HNO₃) + hydrochloric acid (HCl) - is more difficult as silver forms silver chloride (AgCl), affecting the quality of the gold, tin reacts to metastannic acid that hinders gold dissolution and PGM cannot be removed efficiently with aqua regia [89],
- Usually removal of a small number of metals is investigated, while more metals are present in the PWBs. Final metal recovery of all metals has to be considered. However, this is often not or insufficiently discussed through statements like recovery “by use of existing methods like cementation, solvent extraction, adsorption on carbon, electrowinning or ion exchange” [37] or “by sending precipitates to smelters for final metal recovery or creating precipitates of base metals which should be landfilled” [91],
- Direct leaching of the printed wiring boards rarely accomplishes effective extraction of the valuable metals [90] as the leaching agents cannot reach the internal layers of the PWBs. Therefore, extensive size reduction of the circuit boards is necessary to ensure a quick reaction time and high metal recoveries. Particle sizes smaller than 3 mm have been reported [92][89][93][37]. This however could lead to losses of precious metals as discussed in the previous chapter,
- Excessive grinding could release dusts also containing (brominated) flame retardants. High temperatures during shredding could cause development of dioxins during shredding; there is an inverse relation between the particle size and the amount of dioxin generated. Hence, appropriate measures for workers and environment protection have to be taken [82],
- Off-gas control and treatment measures are necessary as during the leaching reactions hazardous or toxic fumes are generated. Leaching of PWBs with nitric acid or aqua regia causes the release of nitrogen oxide vapours and chlorine vapours [37][89],
- The processes require strong acidic or caustic solutions such as cyanide [37], hydrochloric acid, nitric acid and aqua regia as reagents, which have to be handled and disposed of according to EHS standards. Furthermore, the processes have to be well-designed and properly managed in order to prevent pollution incidents and ensure workers’ safety, as these were causes for cyanide pollution incidents in the primary gold industry [94]. The cyanide leaching operations in Korea have stopped because of high labour costs and environmental issues [90],

- The handling of waste streams and by-products is minimally or insufficiently discussed or considered.

Taking all this into account pure hydrometallurgy processes are not as easy as often presented⁸, especially under the conditions in developing and transition countries. They usually will require significant technology and precaution measures to avoid hazardous emissions, as well as the additional use of pyrometallurgy process for optimal/final metal recovery.

To the best of the authors' knowledge, there are no industrial, environmentally sound operations that can be described here as best available technology. Although there are companies that treat PWBs using hydrometallurgy methods and claim to do this in an environmentally sound way, no comprehensive flow sheets for PWBs have been published thus far. Unfortunately, there is also no information about their environmental performance and resource efficiency available in the public domain. Because of this lack of knowledge and inherent technical constraints of mere hydrometallurgical processes **for complex fractions**, the hydrometallurgical alternatives cannot be evaluated using the characteristics for environmentally sound, sustainable processes as done for the integrated smelters.

Consequently, the hydrometallurgical alternative processes cannot be considered innovative until a good, independent evaluation of complete process flows up to final metal recovery can be carried out and compared to current state-of-the-art operations.

3.1.2.2 Metallic fractions with precious metals

Metallic fractions with precious metals consist usually predominantly of copper. These fractions can be treated in copper smelters, which are present in transition and developing countries or in the integrated smelter-refineries described in section 3.1.2.1. As no organic materials are present, the requirements for off-gas cleaning/treatment are lower. The precious metals will collect in the blister copper and after electrolytic refining of the copper, end up in the anode slimes. The slimes will be treated for precious metal recovery, while at the same time the other metals present in the slimes can be recovered if appropriate equipment is installed.

Metallic fractions with precious metals coatings can also be treated in operations that use hydrometallurgical unit operations if good care is taken for the effluent solutions. This involves dissolution of the copper including the precious metals and then recovery of the metals one by one.

3.1.2.3 Metallic fractions without precious metals

In this category non-ferrous, non-aluminium metallic fractions are considered. These are, for example, copper granules, brass, copper-brass mixtures, zinc, lead, tin or mixtures of heavy non-ferrous metals. Usually, these metals are also treated in smelter operations and can be treated together with other industrial by-products or in facilities used for metal production from primary raw materials. Appropriate flow sheets and unit operations are discussed in [78][79][80]. If sufficiently clean, it is also possible to just remelt these fractions into new metal (alloys).

⁸ Interestingly, commercial promoters of hydrometallurgy for e-scrap sometimes use the expression "leaching in aqueous solutions" and avoid speaking of cyanide or nitric acid as leaching agent. It is evident that none of the circuit board metals can be dissolved in pure water, so the suggestive use of "aqueous solutions" sometimes appears to be used by purpose to mislead less educated readers.

3.1.2.4 Aluminium

The aluminium fractions from e-scrap can be remelted to recover the aluminium content. Recycling requires less energy than primary production (5-10% of primary) and can be done without loss of value of the material [38]. Within the aluminium recycling industry a distinction is made between refiners and remelters and between cast and wrought alloys [38], [39], [40], [41]. Refiners produce standard cast alloys from cast and wrought alloy scrap and some primary material, while remelters produce wrought alloys almost only from wrought scrap. The difference between cast and wrought alloys is related to their composition. Cast alloys contain max. 20% alloying elements mainly Si, Mg and Cu and the silicon content is more than 5%. Wrought alloys on the other hand contain max. 10% alloying elements (Mn, Mg, Si, Cu, Zn) and less than 1% silicon. For this reason it is very difficult to obtain wrought alloys out of cast alloys, but it is possible to use wrought alloys to make cast alloys. As a result a distinction between only wrought, only cast and mixed alloys is made. In electronic equipment cast alloys are primarily used and as post-consumer scrap is treated with refiners, the focus will be on this type of aluminium recycling operation. It has to be noted that aluminium from e-waste is only a small part of all recycled aluminium. Main sources are automotive, building and packaging applications.

The recycling process consists of four steps, which will be discussed in more detail:

- Compilation of furnace charge,
- Charging of furnace and melting,
- Refining, alloying and casting,
- Salt slag treatment.

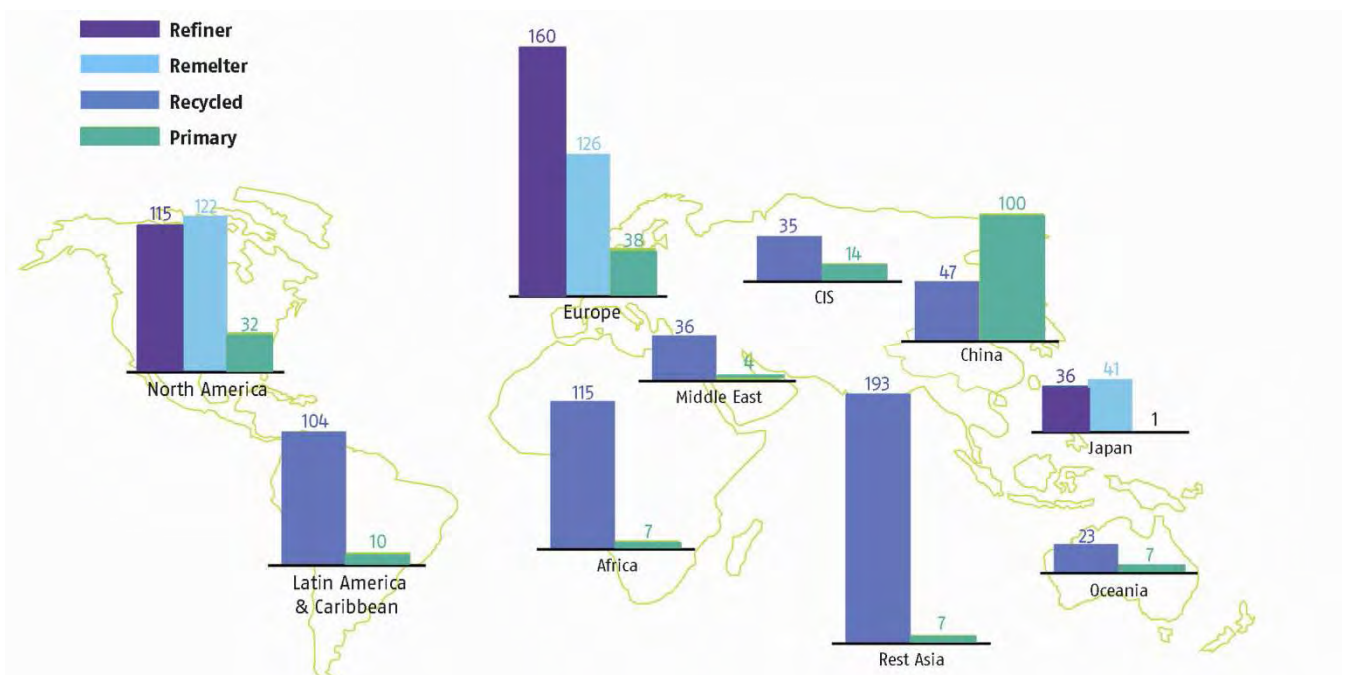

Figure 9: Distribution of aluminium recyclers in the world (2004) [43]

Furnace charge

The aluminium from e-scrap is mixed with other types of scrap in order to obtain the desired standard alloy composition. The mixture is based on sample melts made of each of the different materials entering the remelting facility. It is less important what the source of the material is; it is more important that it is known what the alloy composition and the contamination of the material are. Prior to remelting material with paint can be de-coated, to improve the metal yield, reduce losses and reagent usage.

Melting

As the material is usually contaminated with sand, dirt, oxides, oil, paint or other metal pieces it is necessary to remelt the material using a salt flux. Melting is often done in a (tilted) rotary furnace, containing about 15-25 tons of scrap plus flux [39]. For optimal flexibility with regard to the feed scrap material, a plant would have several different types of furnaces to treat each type of scrap in the most effective manner.

It has to be kept in mind that aluminium recycling is actually a melting process. The aluminium is heated to 700 - 800°C, so that it becomes liquid and can be separated from the solid impurities. The flux, a mixture of sodium and potassium chloride is used to capture impurities, to prevent oxidation of the aluminium metal and to enhance the separation between oxides and aluminium metal. It also captures some aluminium metal from the melt. As no reducing agent is present, any aluminium oxide present in the scrap cannot be converted back to metal and any oxides formed during remelting represent a metal loss [40]. Only during the primary aluminium process can aluminium oxide be converted to metal! During remelting the furnace rotates for an optimal mixing of its contents. When the remelting process is finished, the rotation of the furnace is stopped and the salt slag and the aluminium metal are tapped separately. State of the art technology is used to prevent emissions of dust, acidic gases, VOCs and dioxins to the air [38].

Refining and alloying

The aluminium metal is further refined in a holding furnace, where additions of reagents are used to remove the last unwanted elements. As the refining process is governed by the Laws of Thermodynamics, not all types and levels of impurities can be removed, hence the quality (composition) of the feed material is very important to obtain alloys with the same quality as primary metal. Small additions of alloying elements are made to precisely meet the alloy specifications. After skimming, the alloy is cast into ingots for delivery or it is delivered in liquid form to the manufacturer of aluminium products. The skimmings are recycled as well.

Salt slag treatment

The salt slag obtained from the remelting step, about 300 – 500 kg per ton of aluminium [38] can be treated to recover the salt and the aluminium inside. This is common practice in the Europe, while elsewhere the slag is usually land-filled. In the slag is about 8.5% aluminium, 59% salt and the remainder is oxide [39]. The slag treatment consists of crushing and sieving to remove the aluminium particles, followed by dissolution of the salt in water and finally crystallization of the salt (Figure 10). During the dissolution step any remaining aluminium metal is converted to oxide [39] and some of the impurities in the slag react with the water to an oxide, releasing gaseous compounds [42]. Appropriate gas treatment systems are in place to deal with this in an environmentally sound manner. The oxides in the slag remain behind as solid residue, are dried and later sold for use in concrete, for example. The dissolved salt is precipitated via crystallization and returned to the aluminium remelters to be used as flux again. Only some salt is necessary from primary/natural resources to

compensate the small losses during treatment. All the water obtained during precipitation of the salt is returned to the dissolution step in the slag treatment process in a closed loop system [39] [41].

Driving the aluminium recycling process is the demand for aluminium from the manufacturing industry. As a consequence, when the demand for aluminium decreases, less aluminium will be recycled, because there is no market for the product anymore. Based on the demand for aluminium, the scrap is sourced, which has to be present in sufficient amount to be able to run a plant. In the European context a minimum amount would be 50,000 tons of remelter per year (investment cost approximately EUR 25 million), while a salt slag treatment facility requires a minimum input of 60,000 tons of slag per year. In other words, it needs the slag of two remelting facilities. Furthermore, there has to be a market for the by-products generated during the salt slag recycling. Figure 9 shows the number of primary aluminium producers, remelters, refiners and recyclers in the different countries and regions. It can be seen that aluminium recyclers are quite evenly spread throughout the world, with recycling capacity present in Latin America, Africa and Asia. Thus, equipment/plants for end-processing of aluminium from e-waste is present.

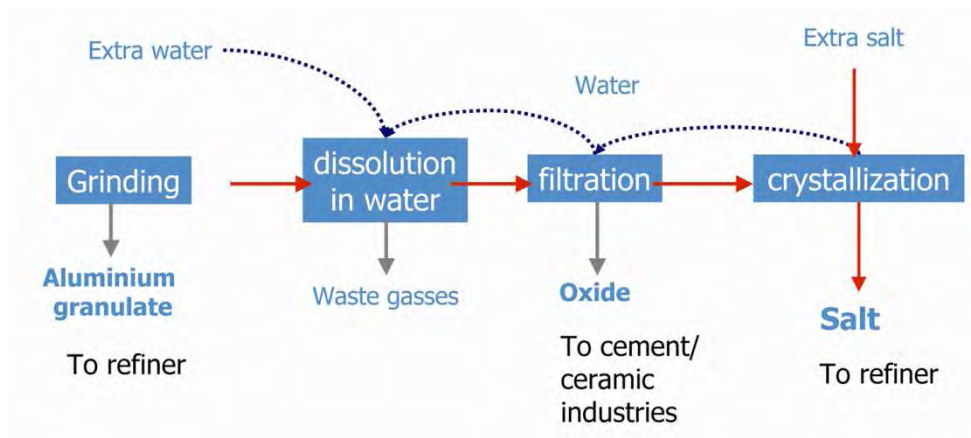

Figure 10: Salt slag treatment in the aluminium recycling process

3.1.2.5 Ferrous Metals

In this category ferrous metals, like iron and steel are considered. Such fractions often represent a relevant mass percentage of appliances like fridges or other large household equipment [18]. To facilitate metal recovery during end-processing, the purity of the iron and steel fractions from e-waste are most important. Efficient removal of metallic copper, lead and tin or their alloys during pre-treatment is necessary as these are undesired elements in the steel remelting process. Liberation of the steel from other materials by shredding, followed by magnetic separation or utilization of manual or semi-automatic methods for separation of the fractions [107], increases the purity to over 98% [80]. Paint usually has to be removed as it can be harmful to the smelting process or can lead to undesired off-gas emissions when appropriate off-gas capturing and cleaning installations are not present.

Recovery and recycling of steel fractions can be done in electric arc furnaces [115], which can be filled with a charge consisting of 100% scrap materials whereby electricity is used to remelt the scrap. The scrap from e-waste can be mixed with scrap from steel-product manufacturers, scrap from steel making operations and with other post-consumer steel waste fractions such as from End-of-life Vehicles and used beverage cans [114]. For

example, in the USA recycled scrap consists of 58% post-consumer scrap, 29% scrap from steel-product manufacturing and 23% scrap from steel making operations [114].

Furthermore, iron and steel scrap can be recycled by using it during the production of iron and steel from primary ores (primary steel making operations). The first step in the process is conversion of the iron ore into pig iron in a blast furnace. The second principle step is the conversion of the pig iron to steel in a Basic Oxygen Furnace (BOF). During the conversion a lot of heat is generated and steel scrap is added for cooling so that the temperature can be kept at 1700°C [115]. The obtained steel is further purified and alloyed in the next step of the process or can be cast directly.

The steel industry is a global industry with processing facilities located throughout the world. Moreover, in industrializing and developing regions steel works are present, for example in Mexico, Brazil, South Africa, India etc. [116]. In the world production of steel totalling 1,344 million tons in 2007, about 36% comes from steel scrap. Of the world steel production about 31% is produced in the electric arc furnace process; the rest results from the primary steel making operations [116].

3.1.2.6 Pb-glass from CRT

The glass obtained after treating CRT monitors can be classified in two groups [83]:

- Front panel glass containing max. 4% lead (Pb),
- Funnel and neck glass containing 22-20 % lead and a conductive coating.

The end-processing of such glass follows three main routes:

- The secondary production of new CRT glass (screen to screen; (lead containing) cone to cone glass; to a lesser extent for mixed glass to cone glass),
- Smelter options (in particular mixed glass to Cu/Pb smelters),
- Other industry (e.g. pane glass to ceramic industry as feldspar replacement; funnel glass to cement industry as coarse gravel replacement; mixed glass to cement industry as fine gravel bricks or to salt mine as filler).

When the panel and funnel glass are not sorted well, it cannot be processed in a glass-to-glass process because of the lead content. For glass-to-glass recycling sorting is very important as the different devices have their own individual glass specifications. In particular for use in panel glass the quality requirements on cullet are strict. Another factor determining the opportunities for glass-to-glass recycling is the demand for CRT glass. This demand has been steadily declining over the past years, as plasma and LCD screens are becoming more and more pervasive instead. As a consequence it can become more and more difficult to do glass-to-glass recycling in the future. Mixed glass then often goes to a lead smelter where it is used as fluxing material. In the lead smelter the lead is recovered along with the copper from the conductive coating. The benefit is use as slag former as well as possible lead recovery. Concentrations of Pb, Ba and Sr in final slags need to be controlled.

For use in other industries, particular technical or legislative restrictions could apply: for instance, in the ceramic industry very well cleaned screen glass can be applied instead of feldspar or other waste flat glass. The re-application of lead-containing cone glass or mixed glass fraction in various industries and other application is judged in different ways. Application of cone and mixed glass in, for instance the cement or building industry is not allowed in some countries (e.g. Germany, United Kingdom, Sweden) but permitted in others (e.g. Netherlands and Belgium).

3.1.2.7 Evaluation of end-processing technologies

In Table 9 a detailed analysis of the end-processing technologies for PWB and aluminium is given.

A wide selection of parameters relating to the sustainability is discussed and where possible quantified. It is clear that environmentally sound end-processing technologies require high investment cost compared to pre-processing technologies, as well as a considerable tonnage to operate such processes economically and a medium to high level of education of the workers.

Therefore, it is most feasible to use existing facilities where possible. The environmental performance of these facilities has to be quantitatively evaluated in order to assess if state-of-the-art efficiencies, EHS regulations and emission standards are met. Locally or regionally available facilities can be used in the case of steel, aluminium and other non-ferrous materials, or globally available facilities when considering treatment of PWBs. This division of labour and changing the local recycling chain into an international recycling chain uses the strengths available in each location to create and support environmentally and economical sustainable businesses and recycling chains.

	Integrated smelter for PWBs	Aluminium smelter
Emission to air, soil, land	Very low	Very low
Energy efficiency	High	High
Use of water and land	Low land use per kg metal produced Low water use because of reuse	Low land and water use per kg Al Low water use during salt slag recycle because of reuse
Use of additional raw material	Low, only some reagents	Low, mainly salt flux
Process security	High level of automation	High level of automation
Workers protection	Clothing and off-gas/vent	Clothing and off-gas/vent
Waste amounts	Little	Little
Final fate waste products	Slag to building industry Hazardous materials to controlled deposit	Salt slag converted to metal, flux and oxides, which go to building industry
Substances recovered	Ag, Au, Pd, Cu, Pb, Sn, Bi, Sb, et al....	Aluminium alloys
Technology used	Combination of pyro- and hydro- metallurgy	Remelter: pyrometallurgy Slag recycler: hydrometallurgy
Feed	PWBs mixed with e-scrap, industrial by-products, other recyclables, manufacturing scrap	Aluminium scrap from e-waste, end-of-life vehicles, buildings, beverage cans and manufacturing industry
Feed requirements	Unshredded PWBs, with main Al and Fe parts removed	Aluminium alloys, with low iron content
Feed availability	Globally sourced from pre-processing	Regionally sourced from pre-processing
Process stability/ feed flexibility	Stability high/ flexibility medium-high	Stable/ flexibility determined by number and types of furnaces
Product quality and value	High, meets metal standards	High, meets alloy standards
Impact on recycling chain	Crucial: final material and value recovery	Crucial: final metal and value recovery
Metal recovery or yield	High	High
Skilled labour	High and medium skilled	High and medium skilled
Investment security	Uncertain	At least 5 – 10 years
Critical size	100 000 t/y	Remelter: 50 000 t/y Slag recycle: 60 000 t/y
Greenfield investment cost (in Europe)	>EUR 1 billion for 350 000 t/y mixed smelter feed	Remelter: EUR 25 million for 50 000 t/y Slag recycle: EUR 35 million for 100 000 t/y

Table 9: Detailed qualitative sustainability analysis for state-of-the-art integrated smelters for printed wiring boards (PWBs) and aluminium smelters

	Waste streams	Economic attributes	Environm. attributes	Social attributes	Innovative technology**
Integrated smelter for non-ferrous (pyro-metallurgical methods) (details in chapter 3.1.2)	Non-ferrous (including printed circuit boards) like Cu, Pb, Zn, Sn or mix	Capital cost high Low net (unit) costs due to economies of scale Local growth potential high	No toxic emissions, presence of good off-gas treatment is crucial Low water use Transport: internationally Little waste products Recovery rates >> 90%	Automated process control so less jobs created Highly skilled workforce EHS*	Yes
Hydro-metallurgical processing	For simple metallic fractions; dissolving of precious metal coatings from metallic surfaces	Capital cost medium-high	Possibly high water use Management/treatment/disposal of waste fractions and reagents is crucial	EHS: crucial Skilled workforce needed	Yes, but not an option at the moment for PWBs, mobile phones or other complex materials as no information in the public domain available for evaluation of the technology
Aluminium remelter/refiner (details in chapter 3.1.2.4)	Aluminium	Capital cost medium –high Net cost low Economies of scale	No toxic emissions Salt slag has to be treated or disposed Env.sound Transport within region or country Water use: low – medium	Job creation: yes Mix of low skilled and high skilled jobs EHS low risks	Yes

* EHS: appropriate measures have to be taken for health of workers and environment, which is done in best available technologies ** For interpretation of the meaning of innovative technology in a recycling chain context see chapter 2.4

Table 10: Identification of innovative end-processing technologies in the e-waste recycling chain

3.2 E-waste volumes in developing countries

3.2.1 Current e-waste flows

The estimates are made mainly based on existing e-waste assessments or related reports, most of which were prepared by one or several partners of the consortium. All the incorporated assessments had limited scope (geographical, e-waste categories). Thus, certain data had to be extrapolated based on additional literature data and/or by comparison with countries where the relevant trends are known. Missing data of generated e-waste was calculated by applying average lifetime estimates with actual quantities put on the respective markets or the stock of specific product groups. The average lifetime estimates are shown in Table 11. Most of the gathered data was available in units. Since different types of equipment differ in weight, the data was converted to metric tons. The estimated weights are also represented in Table 11.

Appliance	Lifetime in years	Weight (kg)
PC + Monitor	5-8	25
Laptop	5-8	5
Printer	5	8
Mobile Phone	4	0.1
TV	8	30
Refrigerator	10	45

Table 11: Estimated Weight and Lifespan of EEE

All information in the reports presented equipment related to ICT (PCs, printers and mobile phones), TVs and refrigerators were selected as product groups. Data of other cooling appliances such as freezers were not available. The product group PC includes desktop (incl. monitors) and laptop computers.

Table 12 shows the quantities of electrical and electronic equipment put on the market in 11 different countries, which were selected according to available country assessments. Other countries of interest that have never been assessed were not included since quantification of e-waste flows without any existing data is difficult and would only lead to very rough estimations. The quantities given in the table include new products, donations and imported second-hand goods. It appears that most of the existing studies predominately cover PCs; only the assessment of South Africa covers all the considered product groups. For Brazil, no sales data were available. Since it was difficult to find additional data, we have refrained from completing the missing information. With exception of data of mobile phones in Senegal and refrigerators in China (marked in grey) which are based on own estimations or extrapolation (see below), all numbers result from data from existing studies.

In Table 13 we present the stock or installed base of the considered products. Data not available in existing studies were completed mainly by using world development indicators or indicators from the CIA World Factbook (WDI, WFB). For refrigerators, own estimations were applied (see below). For printers, an estimation of stock was not conducted. All assumed data are marked in grey.

Table 14 lists the quantities of e-waste generated from the different product groups. Missing data were completed by applying average lifetime estimates based on put on the

market or stock data. Estimated numbers are marked in grey. Although countries like India and China receive large volumes of waste imports, these data only include the national generation of e-waste. We feel that the inclusion of legal/illegal waste import volumes in calculating the technology transfer potential would not be appropriate, having in mind the ongoing political discussions around those issues.

Countries	South Africa [53], [54]	Kenya [55], [56], [57]	Uganda [58]	Morocco [59]	Senegal [60]	Peru [60]
Assessment date	2007	2007	2007	2007	2007	2006
PCs	32 000	5 200	700	15 100	1 100	7 000
Printers	6 800					
Mobile Phones	1 900	150		1 700	140	
TVs	35 800			16 800	4 200	
Refrigerators	22 300					
Countries	Colombia [62]	Mexico [63], [64]	Brazil	India [65], [66], [67]	China [67], [68], [69], [70], [71], [72], [73], [73], [74]	
Assessment date	2006	2003		2007	2007	
PCs	13 600	63 700		140 800	419 100	
Printers				12 000		
Mobile Phones				9 300	15 000	
TVs		224 100		450 000	1 170 000	
Refrigerators				211 500	771 700	

Table 12: Quantity of EEE put on the market in metric tons/year

Countries	South Africa [53], [54]	Kenya [55], [56], [57]	Uganda [58]	Morocco [59]	Senegal [60]	Peru [60]
Assessment date	2007	2007	2007	2007	2007	2006
PCs	99 200	21 300	7 500	67 500	3 100	70 000
Printers						
Mobile Phones	3 400	610	150	3 400	410	880
TVs	189 900	22 600	15 600	151 000	15 000	92 300
Refrigerators	114 000	13 600	9 300	51 600	6 500	55 400
Countries	Colombia [62]	Mexico [63], [64]	Brazil	India [65], [66], [67]	China [67], [68], [69], [70], [71], [72], [73], [73], [74]	
Assessment date	2006	2006	2005	2007	2007	
PCs	57 300	300 000	483 800	425 000	1 324 800	
Printers						
Mobile Phones	3 000	4 500	8 600	27 000	59 200	
TVs	146 400	750 000	1 096 000	1 904 600	11 975 300	
Refrigerators	87 800	447 200	1 150 900	1 142 700	6 750 000	

Table 13: Stock (installed base) of EEE in metric tons/year

Countries	South Africa [53], [54]	Kenya [55], [56], [57]	Uganda [58]	Morocco [59]	Senegal [60]	Peru [60]
Assessment date	2007	2007	2007	2007	2007	2006
PCs	19 400	2 500	1 300	13 500	900	6 000
Printers	4 300	500	250	2 700	180	1 200
Mobile Phones	850	150	40	1 700	100	220
TVs	23 700	2 800	1 900	15 100	1 900	11 500
Refrigerators	11 400	1 400	900	5 200	650	5 500
Countries	Colombia [62]	Mexico [63], [64]	Brazil	India [65], [66], [67]	China [67], [68], [69], [70], [71], [72], [73], [73], [74]	
Assessment date	2006	2006	2005	2007	2007	
PCs	6 500	47 500	96 800	56 300	300 000	
Printers	1 300	9 500	17 200	4 700	60 000	
Mobile Phones	1 200	1 100	2 200	1 700	7 000	
TVs	18 300	166 500	137 000	275 000	1 350 000	
Refrigerators	8 800	44 700	115 100	101 300	495 000	

Table 14: Quantity of e-waste generated in metric tons/year

3.2.1.1 Personal computers

Desktop and laptop computers were the most covered appliances in existing reports. Data of quantities put on the market and e-waste generated were available for all selected countries but Brazil. Sales data of a specific country often is derived from customs- or import statistics. E-waste generation was partly calculated by applying average lifetime estimates with past quantities put on the market. For example, it is assumed that new computers sold in 1998 and second hand computers sold in 2001 will become e-waste by 2006. Another method is to divide the stock by the assumed lifetime. Every 5 – 8 years, the stock of PCs has to be replaced by new equipment, what also results in a quantity of e-waste from PCs. The stock had to be calculated from WDI (Personal Computers, 2005) for South Africa, Peru, Brazil, India and China. For Brazil, e-waste generation from PCs was calculated by dividing the stock by an average lifetime of 5 years.

To compare data between the listed countries, quantities were divided by the population of the respective country. Figure 11 shows the quantities of PCs put on the market in kg per capita and year (kg/cap-year). It appears that South Africa and Mexico, as two of the most

developed countries, lead in computer sales with over 0.6 kg/cap-year, followed by Morocco [53], [63], [59] (0.6 kg kg/cap-year correspond to 24 PCs per 1000 habitants). On the other side, in Kenya, Uganda, Senegal and Peru still very few computers are distributed [55], [58], [60]. In between lie Peru, Colombia and China with around 0.3 kg/ cap-year [61], [62], [71]. By way of comparison, in Europe (EU27) PC sales are on average 1.6 kg/cap-year and in saturated markets like Switzerland 3.2 kg/cap-year.

For Mexico we used data from five years ago. However, due to plausibility considerations, this data was regarded as more accurate than other more current numbers found on the Internet.

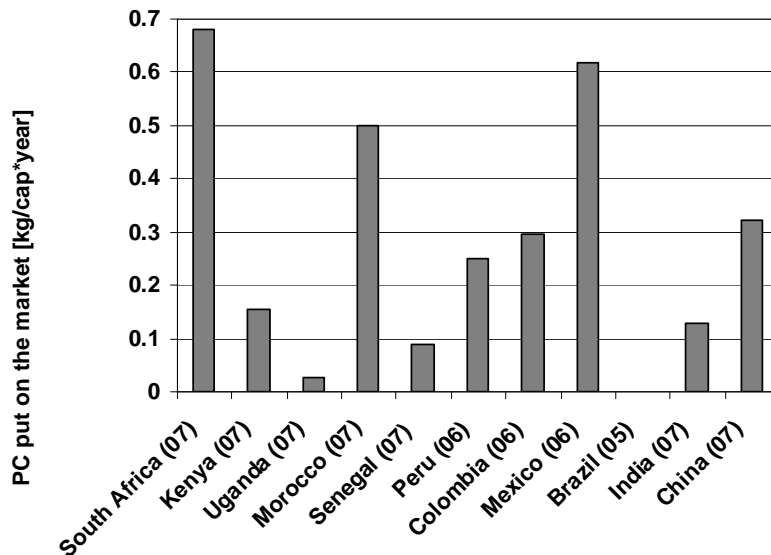

Figure 11: Quantities of PC put on the market in kg/cap-year

If we compare the quantities of e-waste generated from PCs per capita and year, the picture remains generally the same (Figure 12). South Africa, Mexico and Morocco, with high sales rates and a high number of installed computers, also generate the most e-waste. Though Brazil, of which no sales data were available, produces the highest quantity of e-waste with over 0.5 kg/cap-year. According to available data, Peru produces about the same amount of e-waste from PCs as China (ca. 0.2 kg/cap-year) while Kenya, Uganda, Senegal, Colombia and India all generate quantities below 0.15 kg/cap-year. The quantities put on the market and the amount of e-waste generated do not entirely correlate between different countries. The discrepancy could be based on differences in lifespan estimations in the respective reports, on different approaches how e-waste quantities were calculated or on the handling of PCs in the respective countries (reuse storage etc.).

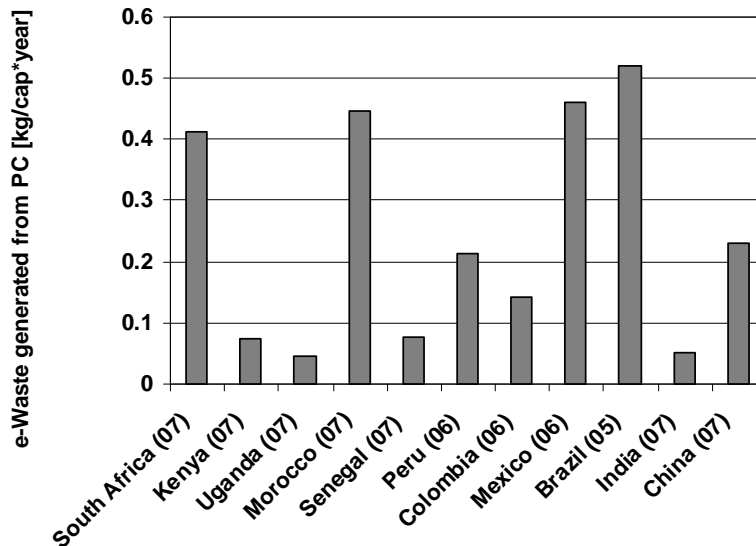

Figure 12: Quantities of e-waste generated from PCs in kg/cap-year

3.2.1.2 Printers

Information about printers put on the market was only available for South Africa and India [53], [65]. In South Africa printer sales account for about one-fifth of PC sales while in India the ratio comes to one-twelfth. Stock data could not be identified. Quantities of e-waste generated from printers were only estimated in the study of e-waste management in Kenya [55]. They again account for approximately one-fifth of e-waste generated from PCs. Since this data correlates with the sales data from South Africa and no data were available to differentiate estimations for the different countries, this ratio was assumed to be applicable for all the observed countries although it is a rough estimation. Only in India were e-waste flows adjusted according to sales data.

3.2.1.3 Mobile phones

Data of mobile phones put on the market could be identified in six countries. Data from Senegal had to be adjusted, since it was assumed that the sales data provided by customs was not complete. Stock data was mainly derived from the number of mobile phone subscribers, assuming that every subscriber owns at least one mobile phone. In South Africa, Uganda and Brazil, the number of subscribers originates from WDI Data (Mobile Phone Subscribers, 2005); for the other countries the numbers were found in the respective studies.

The quantity of e-waste generated from mobile phones was presented in country reports for Morocco, Colombia and India [59], [62], [66]. For the other countries e-waste quantities were estimated by dividing the stock by an assumed lifetime of 4 years (includes reuse). This approach leads to an overestimation of e-waste generated, since the number of subscribers has highly increased in the past years and current flows of e-waste from mobile phones are based on lower sales and stocks from previous years. To correct the overestimation, time series of sales or stock data are necessary, which are only available for China and India [67], [72], [73], [74]. For these two countries, time series has been taken into account to calculate e-waste flows. If we compare the quantities put on the market as well as the e-waste generated from per capita and year (see Figure 13 and 14), Morocco leads with over 0.05

kg/cap-year (500 mobile phones / 1000 habitants) for sales and e-waste, a number which seems rather high and attributes to a low lifetime estimation. In Colombia almost 0.03 kg/cap-year of e-waste from mobile phones are generated. South Africa also has high sales rates per capita and year (0.04 kg/cap-year) but low quantities of e-waste (ca. 0.02 kg/cap-year). In the other countries sales as well as e-waste generated per capita and year from mobile phones are rather low (0.001 – 0.02 kg/cap-year).

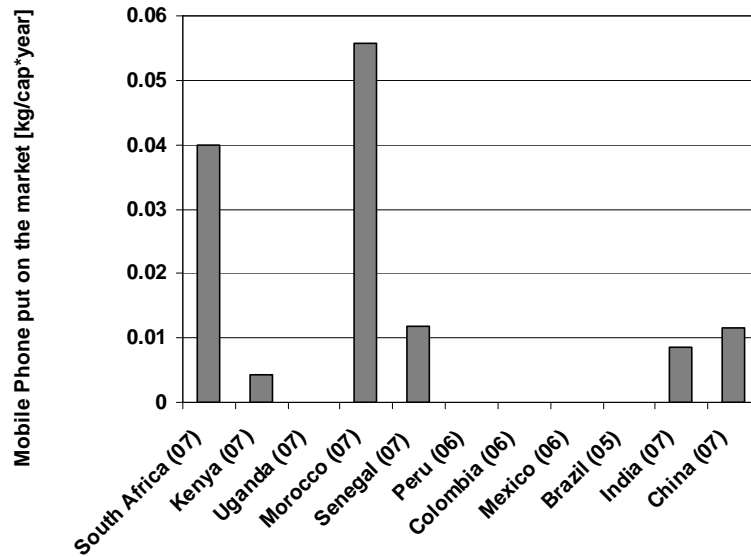

Figure 13: Quantities of mobile phones put on the market in kg/cap-year

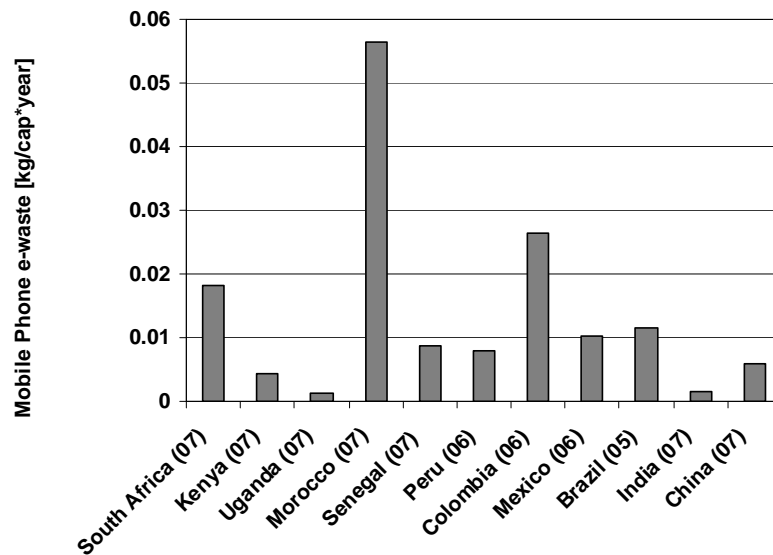

Figure 14: Quantities of e-waste generated from mobile phones in kg/cap-year

3.2.1.4 Televisions

Data from TV sales were also available for six countries. The installed base of televisions however was only identified in Morocco and Senegal [59], [60]. The missing stock data was calculated with WFB data (Television per capita, 2003). With this old data stocks were underestimated, but available time series from China and India [67] show that stocks from TVs increase slowly and the error should not be very significant.

Studies from Morocco, China and India identify quantities of e-waste generated from TVs [59] [66], [68]. Missing data were calculated by dividing the stock data by an average lifetime of 8 years. This again leads to an overestimation of e-waste flows (see chapter 3.2.1.3) but due to the mentioned slow increase of TV sales and stocks, the result should only be a small discrepancy.

The comparison between countries shows that Mexico puts over 2 kg/cap-year (66 TVs /1000 habitants) on the market. The other countries all show sales between 0.3 (Senegal) and 1 kg/cap-year (China).

The comparison is shown in Figure 15.

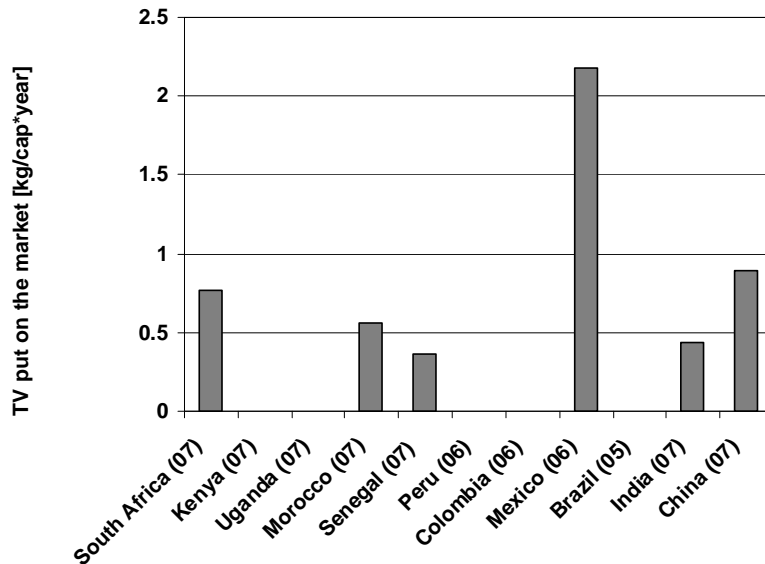

Figure 15: Quantities of televisions put on the market in kg/cap-year

Mexico again generates the highest amount of e-waste from TVs (0.9 kg/cap-year), followed by China and Brazil (0.7 kg/cap-year), South Africa and Morocco (0.5 kg/cap-year). The remaining countries generate e-waste below 0.4 kg/cap-year (see Figure 16).

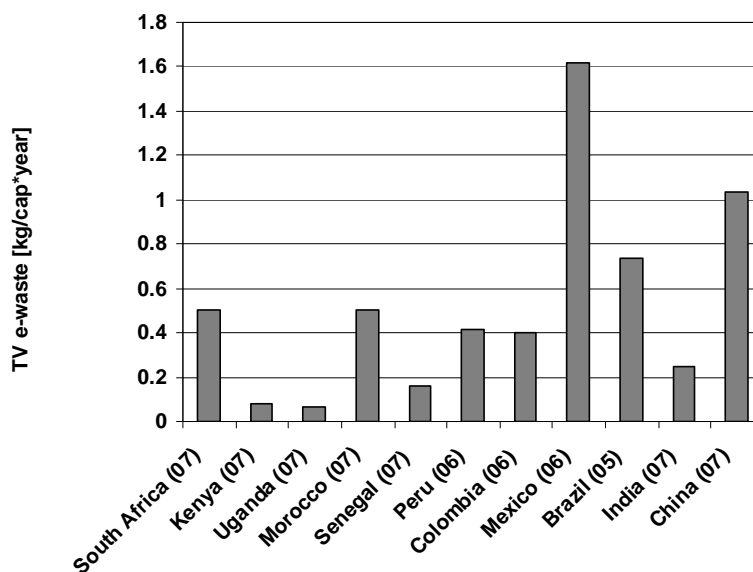

Figure 16: Quantities of e-waste generated from televisions in kg/cap-year

3.2.1.5 Refrigerators

For refrigerators, hardly any data were identified. Sales data were available for South Africa [53] and China [69]. For India sales data from 1994 to 2003 had to be extrapolated, assuming a linear increase derived from the existing data series. Stock data could only be estimated for China using information about numbers of major household appliances owned per 100 households [69]. From comparing the Chinese stock data for refrigerators and TVs, it could be derived that around 40% of people owning a TV also own a refrigerator. Since no more information was available, this rough estimate was used to calculate the installed base of refrigerators in the remaining countries. E-waste generation was calculated by dividing the stock data by an average lifetime of 10 years. A comparison with available e-waste data from India shows that this estimation leads to the right order of magnitude of e-waste quantities from refrigerators.

China puts about 0.6 kg/cap-year (13 refrigerators / 1000 habitants) on the market, while South Africa sales are around 0.5 and India 0.2 kg/cap-year.

According to estimations explained above, Mexico, Brazil and China generate the most e-waste (around 0.4 kg/cap-year), followed by South Africa, Morocco, Peru and Colombia (between 1.5 and 2.5 kg/cap-year). The remaining countries all generate less than 0.1 kg/cap-year of e-waste from refrigerators.

3.2.2 Future e-waste flows

Time series of quantities put on the market or stocks were available for five countries. For South Africa, Uganda and Senegal, time series of PC sales were identified in [54], [58] and [60]. For China time series of PCs, mobile phones and TVs and for India sales data of PCs, mobile phones, TVs and refrigerators [67] were available. Time series of printer sales could not be identified.

Existing time series were extrapolated according to observed characteristics of increase, so that future e-waste flows could be calculated until 2020. For PCs, TVs and refrigerators, on average a linear increase was found. Mobile phone sales and stocks showed an exponential growth in the past years. However, it is improbable that this high growth rate continues in the coming years since saturation will be reached soon. Future e-waste flows were calculated by applying the market supply method or the consumption and use method (for a detailed description of these methods refer to Streicher 2006 [75]), using the lifetimes presented in Table 11, if not otherwise defined in the respective country report according to the references listed in Table 12 – Table 14.

3.2.2.1 Personal computers

The increase in future e-waste flows from PCs varies from country to country. In Uganda where PC penetration is still very low, quantities of e-waste generated will increase by a factor of 6 to 8 by 2020. Similar results were found for Senegal, where present flows of e-waste from PCs will be multiplied by 4 to 8 by 2020, depending on different growth scenarios. Also, in India current flows should be multiplied by 5 until 2020. Figure 17 presents the development of e-waste flows from PCs in Senegal and Uganda from 2005 until 2020.

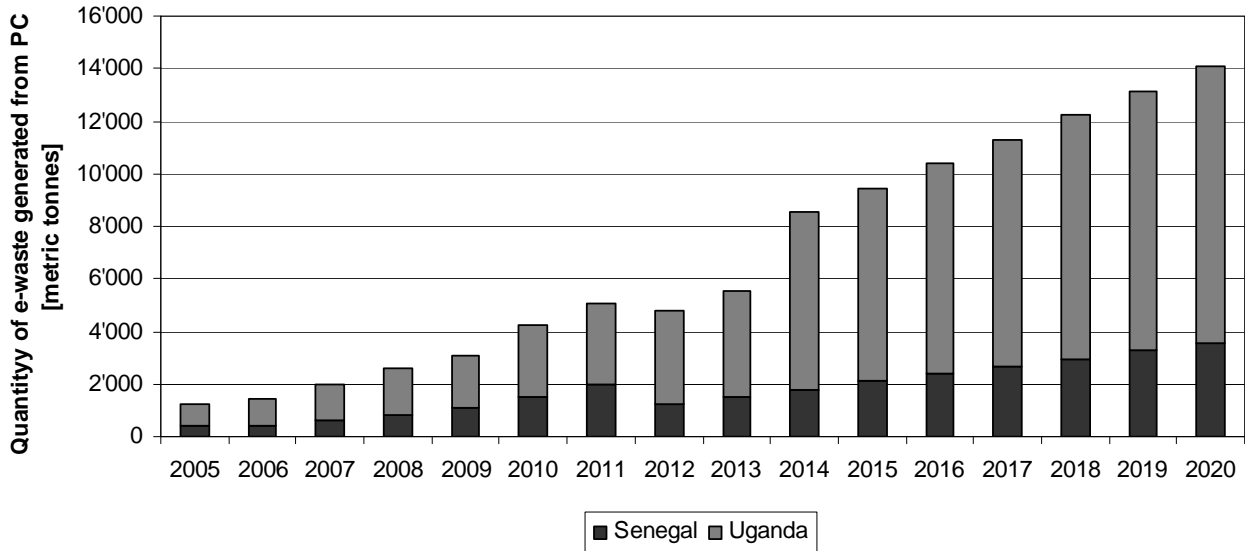

Figure 17: Quantities of e-waste generated from PCs in metric tons from 2005 - 2020

In South Africa and China, where PC penetration is already significantly higher than in Uganda, Senegal and India, it is estimated that e-waste flows will increase by a factor of 2 to 4 by 2020.

For the prediction of e-waste flows from PCs it is important to take the future development of technology into account. Currently, the present market shows a tendency to move away from desktop computers and towards laptop computers. Additionally, CRT-monitors will be substituted by LCD-monitors. Thus, the weight of future e-waste flows will decrease relative to the number of units discarded and the material composition will also change. These developments will have an effect both on recycling technologies and the secondary market.

3.2.2.2 Mobile phones

Mobile phone sales have highly increased in the past few years, for example, in India the current growth rate amounts to over 80%. Therefore, e-waste flows in India, which still were rather low in 2007, will be multiplied by 18 until 2020. In China mobile phone subscribers relative to the population exceed subscribers in India by a factor 4. For this reason e-waste flows will increase less and are estimated to be around 7 times higher than in 2007.

3.2.2.3 TVs

E-waste flows from TVs will not increase as much as flows from PCs and mobile phones, since TV markets, with exception to African countries such as Kenya, Uganda and Senegal, are already closer to saturation. Unfortunately, for these countries no time series of TV sales were available.

In India and China current e-waste flows will be multiplied by a factor 1.5 to 2 by the year 2020. As already mentioned above, new technologies are resulting in the inclusion of lighter equipment, which again will cause a decrease in weight of future e-waste flows.

3.2.2.4 Refrigerators

A time series of sales data for refrigerators was only available for India. Refrigerators put on the market do not show a very high increase rate. Thus, in India e-waste flows from refrigerators will increase by a factor of 2 to 3 by 2020.

3.3 Market potential of innovative e-waste recycling technologies in selected developing countries

In the analysis below it has to be understood that the market potential of innovative recycling technologies is defined through the critical volumes, which can justify the transfer and installation of technologies in order to manage e-waste in the most sustainable way. Hence having a market potential doesn't necessarily mean that an operation can be run in a self-sufficient way (paid by the sales of recycling output fractions or materials). E-waste recycling does not simply mean installing or transferring state-of-the-art, environmentally sustainable and effective technologies in a country taking into account economic boundary conditions. Economics could not simply solve or address the multiple and interlinked issues that enable an effective recycling chain in system design: social, environmental and economic aspects could not be addressed one-by-one, but in holistic approach. Any effort in solving the e-waste problem without taking into account such inter-linkages is most probably doomed to fail. Sustainable recycling of e-waste will always demand for a proper managed framework and a financing scheme, and thus even technology transfer should be addressed in a broader vision. The case of China [112] has already shown how the financing of state-of-the-art e-waste recycling plants fails when not supported by a proper collection network and suffers the completion of informal sector, notwithstanding the economic effort of the government: western high tech equipment could not come as universal cure to financial and social problems hidden behind the e-waste issue.

It would enable the economic instruments more effectively if the compatible policy and general framework of WEEE management are implemented ahead. The example of China e-waste pilot project has shown that under the circumstance of lacking a formal collection system and national regulation of WEEE, even a technology transfer project with abundant subsidy can lead to malfunction. An effective financial scheme is expected to build upon an established recycling chain and complete logistic system. Without identifying the actual system cost (including collection, logistics, recycling and overheads etc.), payers, and beneficiaries, the financial scheme will not function well. In most developing countries, the primary work is to establish relevant WEEE regulation and management scheme, and then a financial scheme can follow up to enhance the implementation of such a management system.

For a more comprehensive discussion of the objectives and framework conditions of sustainable e-waste recycling refer to chapter 2.3.

3.3.1 Market potential of innovative pre-processing technologies

The market potential was estimated as a function of possible volumes of e-waste available for recycling and the typical size of a recycling facility adapting a specific technology. In order to estimate the possible volumes of e-waste available for recycling, it was estimated that a realistic share of 30% of e-waste generated (according to

Table 14) can be accessed. The estimation is based on experiences made in various countries as cited in [53] [55] [59] [60]. However, this requires either to connect to existing

collection systems (e.g. to the informal sector like in India and China or national e-waste management systems like in South Africa) or to implement a new collection system first.

The identified innovative pre-processing technologies all rely on labour intensive manual operations and require rather small investments in hardware. Consequentially, the minimum amount of workers needed for a stand-alone operation is small and, based on experiences from Europe and from a few developing countries, was estimated to be around five full time equivalents (FTEs). Estimated processing volumes per worker and the corresponding minimal volumes needed for the installation of a stand-alone facility is summarized in Table 15. It has to be noted that for volumes smaller than this minimum, the installation of a working space could still be worthwhile when integrated into another operation (e.g. one working space for semi-automatic cut and cleaning of CRTs integrated into a manual dismantling facility for e-waste in general). This case is indicated as “medium” potential in Table 16. The market potential is indicated as “low”, when current e-waste volumes would not be sufficient to give employment for one FTE. This is not the case for any of the selected countries. “High” indicates that expected e-waste volumes would be sufficient to implement a stand-alone facility. Estimations of generated e-waste volumes in 2020 suggest that all countries would have a “high” potential for the adaptation of pre-processing technologies.

Whereas manual dismantling and sorting technologies are already applied in some of the countries there is no indication that other more advanced technologies are applied, such as de-gassing of CFCs and HCFCs and semi-automatic CRT cut and cleaning technologies. Competition for the adaptation of manual dismantling and sorting technologies originate from a large informal sector in China and India and from a formal sector in South Africa. In all other countries e-waste recycling is only just beginning to appear resulting in lack of competition for the adaptation of innovative pre-processing technologies.

	Typical volume processed by 1 FTE ¹⁾ (metric tons / year)	Typical volume processed by a stand-alone facility ²⁾ (metric tons / year)
Manual dismantling/sorting of fractions	30	150
De-gassing CFC, HCFC	200	1 000
Semi-automatic CRT cut and cleaning	200	1 000

¹⁾ FTE = full time equivalent

²⁾ Assuming that a stand-alone facility is viable with five FTEs (not counting overhead personnel)

Table 15: Typical volumes processed in pre-processing recycling facilities

Countries	South Africa	Kenya	Uganda	Morocco	Senegal	Peru	Colombia	Mexico	Brazil	India	China
Manual dismantling/ sorting of fractions	H	H	H	H	H	H	H	H	H	H	H
De-gassing CFC, HCFC	H	M	M	H	M	H	H	H	H	H	H
Semi-automatic CRT cut and cleaning	H	H	H	H	M	H	H	H	H	H	H

Low (L): Potential volume is below the volume, which could be processed by one FTE

Medium (M): Potential volume is below the volume, which could be processed by one stand-alone recycling facility

High (H): Potential volume exceeds the volume, which could be processed by one stand-alone recycling facility

Table 16: Market potential of identified innovative pre-processing technologies by country

3.3.2 Market potential of innovative end-processing technologies

In order to give an idea about the size of existing facilities for the end-processing of e-waste, the throughputs of a few global players are summarized in Table 17. From the numbers it can be observed that there is no integrated smelter for non-ferrous metals concentrating on scrap from e-waste alone. Due to the large volumes and high investments (economies of scale) needed to establish a state-of-the-art facility, this technology can only have a market potential where high volumes can be accessed from a whole region and/or through favourable trade routes. Also, the possibility of integrating the e-scrap into existing primary non-ferrous metals smelter facilities by upgrading the operation could be a favourable factor. This indicates that a potential for integrated smelters has to be assessed with a regional perspective. Taking into account a possible growth of e-waste volumes in the next ten years as presented in chapter 3.2.2, a mid-term market potential for integrated smelters can be seen in China and/or India for the Asian region, in South Africa for the (southern) African region and in a South American country (most probably Brazil or Chile) for Latin America. It has to be noted that for an appropriate upgrading of existing copper or precious metal smelters, significant investments – especially in off-gas treatment installations – as well access to skilled labour and experienced engineers/metallurgist/chemists is a prerequisite. Competition for a possible adaptation of innovative end-processing technologies originates from the export of e-scrap to the existing global players in general. In China and India the informal sector (e.g. gold leaching activities) would be the biggest competitor. New models for the integration and transformation of the informal sector will be crucial, as has been shown in a pilot in Bangalore, India [76] [77].

	Facility	Yearly throughput (metric tons / year)	Thereof from e-waste
Integrated smelter and refinery (pyro- and hydrometallurgy)	Umicore, Antwerp / Belgium	up to 350 000	ca. 10%
	Boliden, Ronnskar / Sweden	ca. 700 000	ca. 5%)
	Noranda Quebec / Canada	ca. 800 000	ca. 5%
Aluminium remelter/refiner	See Figure 9	> 50 000	< 20%

Source: Own estimations; see also [37]

Table 17: Size of global facilities for the end-processing of e-waste material fractions

Countries	South Africa	Kenya	Uganda	Morocco	Senegal	Peru	Colombia	Mexico	Brazil	India	China
Integrated smelter for non- ferrous (pyrometallurgy)	M	L	L	L	L	L	L	M	M	M	H
Aluminium remelter/refiner	H	M	L	M	L	L	M	H	H	H	H

Low (L): Potential national volume and opportunity to act as a regional hub is too low

Medium (M): Potential national volume is low but there is opportunity to act as a regional hub and ensure sufficient volumes

High (H): Potential national volume is sufficient; there is an opportunity to act as regional hub

Table 18: Market potential of the identified innovative end-processing technologies by country

3.3.3 Sustainability impacts of current processes versus innovative technologies

3.3.3.1 Impacts of current processes

All selected developing countries are characterized by informal activities in the e-waste recycling chain (Table 19). Collection, manual dismantling, open burning to recover metals and open dumping of residual fractions are present in all countries. While in some countries these activities are performed by individuals (e.g. South Africa, Kenya, Uganda, Morocco, Senegal, Peru), countries like India and China reveal a large organized informal sector. Meanwhile, the recycled material or components always directly re-enter the production channels due to the scarcity of the resources containing precious metals. The centralized informal recycling locations are always found adjacent to the electronic and electric production centres. This closed loop recycling chain is following the market rules and is rather flexible towards the grim legislation and management. The incentives of reclaiming more material with lower cost become the main reason for the formation of these large-scale informal sectors in developing countries.

In these countries high collection rates of e-waste are achieved by the informal collectors under the economic benefit from both the reuse and material value from the waste equipments. Most of the e-waste is traded to informal recyclers, which prioritize the reclamation of the valuable components and substances from the recycling process. Informal collection doesn't have major negative environmental impacts, in contrary leads often to a high collection rate and bears economical and social benefits for the poor. Thus the inclusion of informal collection can be part of a sustainable recycling system [76].

The informal recycling processes apply manual dismantling as the primary treatment to separate the heterogeneous materials and components physically with simple tools like hammers, screwdrivers, chisels etc. After the dismantling pre-processing, the components with reuse value are immediately shipped to repair shops for selling in the second hand market. The remaining valuable components like the parts containing copper, aluminium, steel, plastics, printer toner, and circuit boards are classified for further treatment. These dismantling processes usually do not have negative impacts on the environment either. One exception is the breaking of CRT glass. As for the collection manual dismantling bears economical and social benefits for the poor. However, the separation and sorting often leads to the loss of valuable material and hence is partly inefficient [77].

Open burning is widely used in all selected developing countries to recover such metals as copper, steel and aluminium from wires, capacitors and other components. The negative impacts have been documented in numerous publications [20].

The informal sector in India and China is known for their widely applied and harmful techniques in de-soldering of PWBs and subsequent leaching of gold [5], [20], [76], [77]. De-soldering of the circuit boards is operated over the coal-fire grill. The circuit boards are placed in a pool of molten lead-tin solder and heated until the chips are removable. Acid baths are applied to partially extract gold from the chips after removed from the circuit board. After most components of the board are picked over, the rest of the boards then often go to large scale burning or acid recovery operations in order that further remaining metals are partly recovered. These activities have not been observed in African countries, Peru and Colombia. Information from Mexico and Brazil were not available to the authors.

Open dumping of residual non-valuable fractions is known from all countries and has caused great damage to the local ecology and the health of the residents [20].

Especially in China and India some formal hydrometallurgical (leaching) plants have been installed over the last years. As addressed in chapter 3.1.2.1 and 3.1.2.2 such operations can handle rather well metallic residues or precious metal coatings from (metal) surfaces, but have inherent technical limits for treatment of complex, interconnected materials. Sincere doubts remain about the technical efficiency and environmental performance if complex PWBs are treated in such operations. So far, to the authors' knowledge no realistic flow sheets of how such plants operate in practice have been published; moreover, mass balances about range of recovered metals and respective yields are missing and it remains widely unclear where leaching residues finally will end up. Unless the contrary can be proven by the plant operators, it must be assumed that the focus of formal leaching operations for PWBs lies on gold and copper ("cherry-picking"), with the remaining material after leaching going to landfills, informal recyclers or integrated smelters.

In many countries formal recyclers exist for metallic fractions like copper, steel and aluminium (Table 19). This ranges from rather simple remelting operations to large metal smelters and refineries. Metallic scraps from e-waste (such as copper wires) usually are treated in these facilities together with mixed metal scraps from other sources or sometimes with mining concentrates. While these pyrometallurgical plants can be effective and

environmentally sound for predominantly metallic fractions, they should not be used for PWBs or other fractions that contain halogenated flame retardants, unless the necessary off-gas treatment installations have been installed.

Countries	South Africa	Kenya	Uganda	Morocco	Senegal	Peru	Colombia	Mexico	Brazil	India	China
Informal											
Collection	X	X	X	X	X	X	X	X	X	X	X
Manual dismantling	X	X	X	X	X	X	X	X	X	X	X
Open burning to recover/ concentrate metals	X	X	X	X	X	X	X	X	X	X	X
De-soldering of PWBs	O	O	O	O	O	O	O	NA	NA	X	X
Leaching of gold from PWBs	O	O	O	O	O	O	O	NA	NA	X	X
Open dumping	X	X	X	X	X	X	X	X	X	X	X
Formal											
Collection B2B	X	X	O	X	O	X	X	X	X	X	X
Collection c2b	X	O	O	O	O	O	O	NA	NA	X	X
Manual dismantling	X	X	O	X	O	X	X	X	X	X	X
Shredding of white goods (without de- gassing CFC, HCFC)	X	NA	NA	X	NA	NA	NA	X	X	X	X
Pyrometallurgical processing in local smelters	X	O	O	O	O	O	O	NA	NA	X	X
Hydrometallurgical processing in local facilities	O	O	O	O	O	O	X	NA	NA	X	X
Export of PWBs	X	X	O	O	O	X	O	X	X	X	X
Export of CRTs	O	X	O	O	O	O	O	O	O	O	O
Disposal in general landfills	X	X	X	X	X	X	X	X	X	X	X
Disposal in hazardous landfills	X	O	O	O	O	NA	X	NA	NA	X	X
Disposal in incinerators	X	O	O	O	O	NA	NA	NA	NA	X	X

X = process is (sometimes) part of the e-waste recycling chain

o = process is inexistent in the country

na = no information available

Table 19: Informal and formal processes in the e-waste recycling chain in selected developing countries

3.3.3.2 Current processes versus innovative technologies

In conclusion it can be noted that informal collection and manual dismantling activities do not necessarily need to be transformed to formalized processes and often have advantages over the introduction of new technologies from a sustainability point of view.

The informal collection system is rather efficient in countries like India and China because the daily informal collectors are penetrating each community and city to collect e-waste from house to house. They are flexible with working hours and location, they pay a reasonable price to the consumers and are in charge of all the transportation work. This approach not only brings daily income for these informal collectors, but also contributes to high collection rates by not putting extra pressure on the consumers to send their waste to the assigned points. This approach is adapted well to the local situation and the future formal collection system should make the advantage of this group of distributed informal collectors.

Regarding informal pre-processing technologies, deep-level manual dismantling is preferred by most of the informal recyclers, because this is beneficial to separate the whole equipment into purer fractions. This approach is rather preferable in developing countries due to the reason that the labour cost is comparatively low and the work force abundant. Systematic deep-level dismantling serves as a good preparation for the refinery, reuse and material recycling in the next phase.

However, all other informal activities bear great adverse environmental and social impacts and often are also less attractive from an economical point of view than innovative technologies as identified in the chapters above. The primitive approaches adopted by the informal recyclers to extract raw material from PWBs, wires and other metal-bearing components are hazardous to the environment and also achieve very low material recovery rates. In this phase there is a large space for improvement. Introducing easy-operating equipment and methods, educating and training the informal recyclers and gradually formalizing the informal recyclers into the centralized industrial zones are possible approaches, which allow for technological improvement and make use of the scale of economy.

The application of recycling technologies in formalized operations is twofold. On the one hand sustainable technologies exist, which often are a result of individual or corporate initiatives paired with financing sources from national or international development or corporate social responsibility programmes. On the other hand there are a number of inefficient and unsustainable operations, which lack EHS standards and best practices. These operations often were initiated by innovative entrepreneurs but didn't develop towards current standards due to no access to financial resources and know-how, as well as the absence of appropriate legislation and enforcement. It is thought that these operations could adapt innovative technologies themselves as identified in this report, only after receiving support through a technology transfer programme and substantial improvement of their processes towards sustainable operations.

3.4 Comparative analysis and classification of countries

The following comparative analysis is based on the results as presented in chapters 3.3 and on the expert opinion of the authors. As shown in Table 19 all selected developing countries feature a formal and informal e-waste recycling sector. These findings were analysed qualitatively based on the specific country background literature as listed in Table 11 and Table 13 and are graphically depicted in Figure 18 in order to show the dimension of the recycling sectors. The graph is divided into four quadrants representing different shares of the recycling market between the informal and the formal sector. Normally, a sustainable recycling system should grow towards the upper right corner of the graph, where most of the established recycling schemes in Europe are located now. In Europe the informal sector only exists as an exceptional case, if at all. However, this should not prejudice informal recycling

activities being unsustainable per se. Depending on the socio-economic and cultural context of a country, a sustainable recycling system could include an organized informal collection system and the first steps of informal pre-processing as well (compare previous chapter) [76][77].

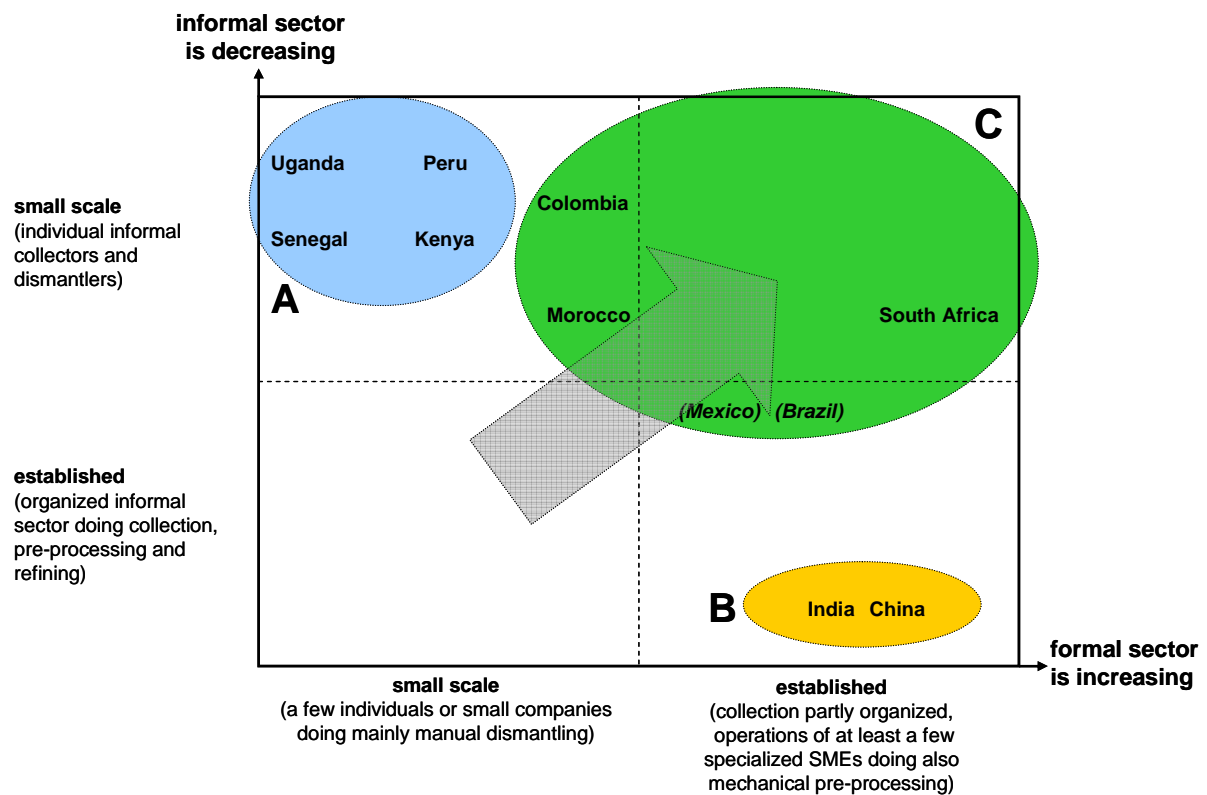

Figure 18: Comparative analysis of selected developing countries regarding the dimension of the formal and informal e-waste recycling sector

It can be seen that none of the selected countries feature an established informal recycling sector while not having an established formal recycling sector at the same time. It is thought that in emerging and large economies like India and China both sectors depend on each other, while it is also known that both sectors in these countries mainly operate in an unsustainable way.

The figure allows classifying the selected countries into three different groups:

Group A (Kenya, Uganda, Senegal, Peru)

This group includes countries featuring the formal and informal sector on a small scale, if existent at all. E-waste volumes were too small for the formation of informal or formal recycling activities. As e-waste volumes also increase over time, those countries typically could move towards more informal activities if appropriate measures are not taken. Group A is classified as promising for the introduction of pre-processing technologies with a strong support in capacity building.

Group B (India, China)

This group includes countries featuring an established informal and formal sector. E-waste volumes are large and in turn a well-organized informal sector was formed. The formal sector operates as a downstream partner and was not able to establish itself as a competitor

for activities typically performed by the informal sector. However, provided a better control of the informal sector, these countries would have the technological and economical capacity to adapt sustainable recycling technologies. Group B is classified as having a significant potential for the introduction of pre- and end-processing technologies with a strong support in capacity building in the informal sector.

Group C (South Africa, Morocco, Colombia, Mexico, Brazil⁹)

This group includes countries featuring a currently developing or already established formal recycling sector, while informal activities remain on a small or medium scale. Group C is classified as having a significant potential to adapt pre- and to some extent end-processing technologies to their own needs, following a technology and knowledge exchange.

3.5 Identification of barriers for the transfer of sustainable e-waste recycling technologies

Country specific barriers for the transfer of sustainable e-waste recycling technologies represent a segment of barriers for the implementation of sustainable e-waste management systems. Thus, the most comprehensive e-waste assessment reports, which were analysing country specific weaknesses and threats, were taken as a basis for this chapter.

3.5.1 South Africa

The South African e-waste landscape has been analysed since 2003 in conjunction with the Swiss e-Waste Programme¹⁰. For approximately 16 years South Africa has featured a small e-waste recycling industry and has developed since then, including the implementation of an industry driven e-waste recycling compliance scheme¹¹. The identified barriers for the transfer of e-waste technology have to be understood considering these framework conditions. The analysis has been done based on two comprehensive reports by Dittke (2007) [95] and Finlay and Liechti, 2008 [53].

- Policy and Legislation**
- South Africa currently does not have any dedicated legislation dealing with e-waste,
 - Laws having a bearing on e-waste include topics like the environment, water, air, waste, hazardous substances as well as health and safety. Answers are certainly found in each of these, however, examines the issue from a different perspective, thereby confusing the problem,
 - Enforcement of these laws is done by different government departments, alternatively levels of government, so that there is no uniform approach in dealing with e-waste or hazardous waste in general,
 - Some by-laws at the municipal level have a potentially negative impact on recycling or collection activities insofar as hazardous waste, storage, collection and transport are concerned. While it is debatable to what extent e-waste should

⁹ Since the information about the e-waste recycling situation in Mexico and Brazil was limited the classification of these countries remains preliminary and needs further investigations.

¹⁰ <http://ewasteguide.info>

¹¹ <http://www.ewasa.org>

be treated (in the same manner as other hazardous waste in terms of collection, storage and transport), it nonetheless poses a possible difficulty for e-waste recyclers,

- There often is a rivalry and lack of cooperation between national and provincial government; this is since both share the constitutional power over pollution control.

Technology and Skills

- Many e-waste recyclers and refurbishers are not yet ISO compliant. While environmental management programmes are in place, challenges exist, including on-site incineration, exposed e-waste and the insufficient containment of potential site run-off,
- Lack of enforcement of EHS standards (workers protection, lack of safety equipment and safety information),
- Hazardous disposal of e-waste fraction is minimal. Potentially hazardous e-waste is disposed of in landfills.

Business and Financing

- Logistics, especially transport costs, are a key challenge to a sustainable e-waste management system. For white goods, storage costs and floor space are key cost drivers,
- Costs for disposing and transport of hazardous waste are cited as key concerns for large-scale recycling business models,
- Formal recyclers possibly could exploit informal workers for their purposes (e.g. no guaranteed income),
- Crime and recycling industry corruption,
- Illegal trading (e.g. with Telkom cabling).

3.5.2 Kenya

The analysis in Kenya is based on the e-waste assessment report by Waema and Mureithi (2008) [96]. It also takes into consideration findings of previous studies in the field of e-waste management by Berry and Hugh (2007) [56] and Basiye (2008) [97]. Major barriers for the transfer of sustainable e-waste recycling technologies are summarized below:

Policy and Legislation

- Potential of political instability in Kenya,
- Low national priority for e-waste,
- No mechanism to implement the policy intentions (e.g. MoIC policy statement),
- Limited capacity of the important government agencies to deal with e-waste,
- Lack of coordinated approach across the ministries to deal with e-waste,
- No regulatory and policy structures to safeguard health, environmental and social consequences of e-waste,
- Players in e-waste not recognized by the policy and legislative framework.

Technology and Skills

- No infrastructure available for the disposal of the hazardous fraction from e-waste,
- Lack of a mechanism to separate e-waste from solid waste;
- Lack of collection systems leads to e-waste being stockpiled in

homes, offices and repair shops,

- Lack of awareness of the need for an e-waste management system.
- No or limited extended supplier responsibility,
- Most electrical and electronic appliances have a value to their owner, even if it is broken. Hence people expect to receive something when giving it away for disposal. This implies that well designed incentive methods will be needed and might have impacts on recycling costs.

Business and Financing

3.5.3 Uganda

The most comprehensive analysis of strength and weaknesses of the current e-waste situation has been summarized in Wasswa and Schluep (2008) [98]. This analysis serves as the basis of the identification of barriers for technology transfer:

- | | |
|-------------------------------|---|
| Policy and Legislation | <ul style="list-style-type: none"> • No specific policy or legislation for e-waste management. |
| Technology and Skills | <ul style="list-style-type: none"> • No special infrastructure available for the formal collection and recycling of e-waste. Also, informal collection activities are happening on a very small scale only. This limits the access to the e-waste generated, • There is a general lack of awareness among consumers and collectors of the potential hazards of e-waste to human health and the environment. |
| Business and Financing | <ul style="list-style-type: none"> • No infrastructure available for the disposal of the hazardous fractions from e-waste, • The total amount of installed computers in Uganda is still very low. Although volumes will increase within the next year, the potential for the application of certain technologies will be limited by the volumes of e-waste generated, • Uganda is a land-locked country which complicates the export of problematic e-waste fractions, which cannot be treated in the country. |

3.5.4 Morocco

The most comprehensive analysis of strength and weaknesses of the current e-waste situation has been summarized in Laissaoui and Rochat (2008) [59]. This analysis serves as the basis of the identification of barriers for technology transfer:

- | | |
|-------------------------------|--|
| Policy and Legislation | <ul style="list-style-type: none"> • At present, there is no specific legislation on e-waste. However, law No. 28-00 on the management and disposal of waste could lead to a decree specifically applicable to this type of waste; • A strong institutional framework exists for the ITC sector, in which an e-waste policy could be included; • Strong social programmes exist for the support of the informal sector. |
|-------------------------------|--|

- Technology and Skills**
- The e-waste recycling sector is dominated by the informal sector. Hazardous operations such as open-sky incineration have been observed;
 - The first formal initiatives are appearing but need financial and technical support;
 - No infrastructure available for the disposal of the hazardous fractions from e-waste.
- Business and Financing**
- All costs, including collection, transport and disposal of hazardous fractions at the charge of the recyclers;
 - No secure financing of non-profitable recycling operations.

3.5.5 Senegal

The most comprehensive analysis of strengths and weaknesses of the current e-waste situation has been summarized in Wone and Rochat (2008) [60]. This analysis serves as the basis of the identification of barriers for technology transfer:

- Policy and Legislation**
- No specific policy or legislation for e-waste management,
 - Weak implementation of municipal waste management policies,
 - Roles and responsibilities of stakeholders are not defined.
- Technology and Skills**
- E-waste recycling sector inexistent,
 - Informal metal scrap dealers treat copper and iron fractions in e-waste,
 - All e-waste ends up in landfills (uncontrolled).
- Business and Financing**
- Estimated quantities of generated e-waste are very low, and may make recycling businesses non-viable,
 - Institutional framework for securing the financing of non-profitable recycling operations is weak.

3.5.6 Peru

The Peruvian e-waste landscape has been analysed since the beginning of 2007, when the Swiss e-waste Programme started preliminary clarifications about a possible programme extension to Latin America with target countries Peru and Colombia. The analysis is based on the e-waste assessment report by Espinoza (2008) [61] and Empa's efforts to define an implementation project with the main stakeholders.

- Policy and Legislation**
- Peru currently does not have any dedicated legislation dealing with e-waste,
 - The recently established Ministry of Environment is aware about e-waste being an issue of great importance, but hasn't officially put it on its political agenda. It will be key to motivate the government to take action in the issue,
 - Almost all the specific waste management systems that have been set up in Peru thus far - polyethylene terephthalate (PET), cans, glass - are the result of effort from the private sector.

- Technology and Skills**
- There are only a few recyclers, mostly interested in PWBs (“cherry pickers”), all without certification. One of them has been exporting PWBs for several years now,
 - In Peru, a high activity of informal dealing, reuse, disassembly, recycling and disposal of electronic waste can be observed,
 - Hazardous disposal of e-waste fractions is minimal up until now. Potentially hazardous e-waste is mainly disposed of in landfills.
- Business and Financing**
- There is a large formal and informal local computer assembly industry, which is estimated to be 75% of the entire market;,
 - There is a not insignificant amount of used computers that are imported into Peru every year. These can be found afterwards on the second hand markets.
 - There are a few examples of original equipment manufacturers (OEMs) take-back campaigns, but all are individual and rather on a small scale;
 - Most electrical and electronic appliances have a value to their owner, even if it is broken or not in use anymore. Hence people expect to receive something when giving it away for disposal. This implies that well designed incentive methods will be needed and might have impacts on recycling costs.

3.5.7 Colombia

The Colombian e-waste landscape has been analysed since the beginning of 2007 when Empa started preliminary clarifications about a possible programme extension to Latin America with target countries Colombia and Peru. The analysis is based on the e-waste assessment report by Ott (2008) [62], a sustainability analysis of computer refurbishment by Marthaler (2008) [99] and Empa’s efforts to define an implementation project with the main stakeholders.

- Policy and Legislation**
- Colombia currently does not have any dedicated legislation dealing with e-waste. Nevertheless, the principle of extended producer responsibility is included in the environmental law;
 - A specific regulation for end-of-life products in general is in preparation,
 - In Colombia the topic of e-waste is already on the political agenda. In particular the Ministry of Environment has declared it a high priority issue,
 - The Ministry of Environment has signed voluntary agreements with the private sector in order to implement take-back pilot campaigns. The take-back pilot with the mobile phone industry has already started; an agreement with the lighting industry has just been signed,
 - Due to a failed negotiation with the computer industry to sign a similar agreement, the Ministry of Environment is now preparing a specific regulation for computers and peripherals, mainly to increase the pressure on the industry,

- Since it has not been decided whether or not to classify e-waste as hazardous waste, there is still no consensus about the required certifications for recyclers.
- Technology and Skills**
- There are only a few certified recyclers applying different business models. Most of them are considered “cherry pickers”,
 - There is a huge interest in the creation of recycling companies, but a huge lack of know-how. There is a common tendency of wanting to do it all (from take-back to precious metal recovery) instead of focusing on a specific part of the recycling chain,
 - Colombia hosts the most successful social computer refurbishment programme in Latin America, Computadores para Educar, which has recently started to disassemble the e-waste generated by the programme over the years,
 - Hazardous disposal of e-waste fractions is minimal up until now. Potentially hazardous e-waste is mainly disposed of in landfills. Nevertheless, open cable burning and inadequate disposal of certain fractions can be observed.
- Business and Financing**
- The large numbers of electronic devices smuggled into the country represents a serious problem, although the smuggling has decreased over the past few years. Illegal trading, e.g. with copper cabling and other non-ferrous metals are also a problem,
 - Logistics, especially transport costs, are a key challenge to a sustainable e-waste management system, especially due to the country’s size and topography,
 - The not yet solved recycling of many “worthless” but potentially hazardous fractions (e.g. plastics with flame retardants, CRT glass etc.) is cited as a key concern for current large-scale recycling business models,
 - Most electrical and electronic appliances have a value to their owner, even if it is broken or not in use anymore. Hence people expect to receive something when giving it away for disposal. This implies that well designed incentive methods will be needed and might have impacts on recycling costs.

3.5.8 Mexico

Information on the e-waste situation is scarce and the authors were not involved in any analysis themselves to that stage. Reports exist from 2004 (Gonzalez 2004) [100] and 2007 (Roman 2007) [63] from where a few analysing statements could be derived.

- Policy and Legislation**
- The vast majority of the 2,443 Mexican municipalities do not have the legal infrastructure or the economic or human means to address the municipal solid waste (MSW) problem at this moment in time,
 - No bans on the use of landfills for specific types of waste are

in place; therefore, there is no incentive to add non-hazardous-industrial waste to the MSW stream.

- Technology and Skills**
 - No information
- Business and Financing**
 - Many electrical and electronic products are kept in homes or in shops at the end of their lifecycle. The owners of such equipment believe that their obsolete equipment may have additional value to them. The tendency to hoard, however, creates difficulty at the design stage of a collection programme when the quantity of electronic waste needs to be defined.

3.5.9 Brazil

Information on the e-waste situation in Brazil is scarce and no comprehensive assessment studies are known to us. The information below is based on a one week fact finding mission in Brazil by Empa in October 2008 and thus information is preliminary and incomplete. It is planned to perform a more detailed assessment study in Brazil at the beginning of 2009.

- Policy and Legislation**
 - At the federal level the lack of a comprehensive waste management law can be seen as a major obstacle to develop a specific e-waste regulation.
- Technology and Skills**
 - E-waste recycling in Brazil exists country-wide and specializes on material fractions, which have a high aggregated value (such as printed wiring boards, stainless steel, copper containing components etc.). Therefore, it is expected that e-waste recycling currently is done on a “cherry-picking” basis and not in a sustainable way.
- Business and Financing**
 - E-waste seems not to be a high priority for the federal industry association representing the majority of the ICT producing or assembling industries
 - An e-waste system with an additional recycling fee seems to be very unpopular, as the Brazilian tax system already puts high burdens on producers and consumers.

3.5.10 India

The Indian e-waste landscape has been analysed since 2003 in conjunction with the Swiss e-Waste Programme¹². India's e-waste recycling industry is dominated by the so-called informal sector, where tens of thousands of people are estimated to make their living from material recovery. Several attempts to define a legal framework have been unsuccessful. The identified barriers for the transfer of e-waste technology have to be understood considering these framework conditions.

- Policy and Legislation**
 - India currently does not have any dedicated legislation dealing with e-waste,
 - Laws having a bearing on e-waste include topics like the environment, water, air, municipal waste and hazardous

¹² <http://ewasteguide.info>

waste. E-waste handling is currently regulated under the Hazardous Waste Management and handling rules,

- Application procedures to obtain export licenses for the shipment of some special fractions of e-waste to state-of-the-art smelters abroad are unclear,
- Application of the Basel Convention is unclear,
- High level of corruption in law enforcement,
- No definition of roles and responsibilities of stakeholders.

Technology and Skills

- E-waste recycling sector dominated by the informal sector. Low technologies are applied by low-skilled workers, resulting in high health and environment risks, including open-sky incineration and wet chemical leaching of metals,
- No proper solution for hazardous fractions contained in e-waste.

Business and Financing

- Logistics, especially collection and transport, are the main challenge for the formal recycling sector,
- Difficulties to access the materials and direct competition with the informal sector,
- All costs, including collection, transport and disposal of hazardous fractions at the charge of the recyclers,
- No secure financing of non-profitable recycling operations.

3.5.11 China

There have been several international and national e-waste pilot projects conducted in China. Among them, a Swiss-Sino cooperation pilot project is the first large scale scheme in China dedicated to set up e-waste recycling facilities in four target cities across China since 2004. A UNU/StEP project is now carrying out research exploring the eco-efficient recycling approach adapted to the Chinese local situation. The following analysis is derived from the experience and feedbacks of these two main projects.

Policy and Legislation

- The legislative process over the e-waste management is slow. A detailed article on defining the producers' and consumers' responsibilities, collection and recycling target, specific financial and subsidy plan is missing,
- Trying to use one standard policy to implement the e-waste management for various regions and provinces in China is difficult, which has different economical and social situation across the country,
- There are several governmental departments and ministries are engaged in the making of legislations and management within their own focus and territory. A clear specification of respective responsibilities for these governmental bodies is missing and there is no one overall platform to coordinate the whole work,
- Due to the hierarchy and bureaucracy of the Chinese legislation system, the provincial and city level government might implement the policy according to their own

interpretation of the policy from the central government, which would bring great complexity and confusion to the whole national system.

Technology and Skills

- For the informal recyclers, they use primitive methods to further extract valuable material from the components, which bring great damage to the workers' health and local environment. Basic working protection and medical insurance is not available,
- For the formal recyclers of the national pilot project, technologies and equipments from the developed countries are preferred and imported, which is not totally appropriate for China's local situation,
- Formal infrastructures like pyrometallurgical smelters for PWBs recycling, high-standard landfill for hazardous waste and incineration plants for specific waste streams are not fully installed.

Business and Financing

- The existing informal collectors and recyclers have formed a mature trading network for e-waste resources, which is also deeply coupled with the electronic production industries to provide them raw materials. This close material and financial circle is rather inflexible and it is very difficult to intervene by policy or market adjustment,
- The consumers in China have low awareness about the pollution from the informal e-waste recycling. They tend to sell their end-of-life (EOL) equipment to the informal collectors for positive earnings. This habit will cost the future formal collection system and how much waste equipment formal collectors could receive from the consumers,
- The economics of the informal sector largely depends on reuse of products and components (which allows them to buy end-of-life products from the last user at remarkable prices); a purely on material recycling focused formal sector consequently cannot be competitive with this business model of the informal sector without significant subsidies,
- The formal recyclers from the national pilot project receive abundant support and financial subsidies from the government, but they lack the incentive to be economically independent and are less proactive to seek a more cost-effective recycling approach.

3.6 Assessment of mechanisms for technology transfer including financial mechanisms, technical support etc.

Technology transfer in developing countries embraces different key aspects that should be kept in mind to prevent boundary conditions from hampering the aim of the transfer itself. The aim of technology transfer for e-waste recycling should enable two key elements:

- High collection rate for environmental (control over hazardous, recovery environmental value from materials), economic (recovery of value from materials) and social (job creation) reasons,
- Best choice in system design (address responsibilities and actors having best leverages) and environmental outcomes.

This means that financing of technology transfer could not merely be reduced to the setting up of recycling infrastructure without taking into account economic and social boundary conditions. The case of China [112] has shown how the financing of state-of-the-art e-waste recycling plants fails when not supported by a proper collection network and suffers the completion of informal sector. Transfer of technology without taking into account (i) the amount of e-waste to be processed in such plants, (ii) social and cultural boundary conditions and (iii) role of existing informal sector hampered and resulted in failure of such pilot projects. Technology transfer is not merely a simple duplication of technology from developed countries to developing countries. Local situations like available investment, economic conditions, local treatment standards, awareness and education of workers and management level of the recycling chain should be considered when introducing new technology. A selection of the available technology for a specific country can follow the criteria depicted in section 2.4, which can be applied for evaluating the sustainability and practicability of proposed technology. A continuous feedback from the real-time operation would be valuable for make adaption and adjustment of the introduced technology towards the local context, which can be accomplished by local research institutes or recyclers.

Technology transfer should then focus not only on how to achieve the most suitable technological solution for local e-waste processing, but rather on enabling the development of the best boundary conditions for development and sustainability of an e-waste industry. At the end this would lead to the need for a policy design that would ensure a financing mechanism for e-waste collection and treatment that could provide an incentive to collect more – ensuring the needed quantities to any technology in place – and treat better – ensuring high environmental and economic standards.

Financing of downstream e-waste activities and allocation of economic responsibilities along the downstream chain has proven to be challenging in countries with existing take-back schemes and in countries discussing potential take-back system architectures. The way stakeholders financially contribute to different activities varies and many models exist. From a general perspective, there are three main stakeholders who could bear responsibility for end-of-life electronics products:

- The entire society: As e-waste is a societal problem, having impact not only on consumers but also on the entire population (both in terms of environmental and societal impacts), systems could be financed by the entire society (e.g. by taxpayers), especially when governmental organizations keep control over operations,
- The consumers: This could be seen as an implementation of the “polluter pays principle”, where the polluter is recognized as the person responsible for discarding an end-of-life appliance. It could also be argued that even though a producer may bear financial responsibility, consumers will eventually pay the end-of-life costs as an increase of the product price, even when no up-front external charges are paid at point of sale,
- The producers: This is implementation of various degrees of the extended producer responsibility principle. It should be noted that even when financing of systems is ensured by producers, this could result in internalization of costs in the product price by means of (i) a reduction of the producers’ sales margins, resulting in the financial

impact fully borne by the producer or (ii) an increase of sales price, resulting in the financial impact indirectly borne by the consumer.

The choice between a reduction of sales margins or an increase in sales price is not strictly dependent on the financing model of the entire system, even if advocates of EPR usually speak simply of cost internalization as a reduction in margins – notwithstanding different costs and margins structures for different products exist. Such choice involves many complex issues and depends on each individual company's strategy and product portfolio. The current implementation of the Producer Responsibility Principle across Europe has not always been an incentive to collect more, simply because stakeholders responsible for financing have no economic benefits in increasing the collected amount.

The definition of “financing models” is critical to understanding the design and operation of e-waste take-back systems and thus the potential success of any effort of technology transfer. The relationships between the stakeholders involved in a system and the financial flows are specified by financing models. Based on the differences in the operative and financial structures of systems in place around the world, it's possible to define at least four generic financing models [113]. These models identify the relationship between stakeholders (e.g. between producers, compliance schemes and final users) and the level of responsibility of the system managers. They are divided into:

- Compliance Cost: Producers finance activities in the system, bearing costs for management of all e-waste (joining a compliance scheme or financing their own take-back system or product stewardship programme),
- Compliance Cost & Visible Fee: Producers finance activities in the system, bearing costs for management of waste they put on market (joining a compliance scheme or financing their own take-back system). They also bear costs for management of e-waste put on the market by other producers in the past (historical waste) but they use a Visible Fee to get money back from final users in respect of historical waste management costs. The EU WEEE Directive has introduced such a mechanism, initially,
- Reimbursed Compliance Cost: Producers finance activities in the system, bearing costs for management of e-waste but they use a Visible Fee to get money back from final users in respect of entire e-waste management costs. Producers simply finance compliance schemes in advance when placing appliances on the market but get the money back when selling appliances to final users,
- Recycling Fee: Final users, when buying new equipment, bear costs for management of e-waste. There's no involvement of producers. Recycling Fees usually are calculated as a share of actual costs of recycling arising WEEE (Shared Recycling Fee): this means that recycling costs currently arising are shared on appliances being sold.

Any technology transfer effort should then focus first on the boundary conditions that could ensure sustainability of the e-waste industry. In particular incentive should be found in order to promote:

- Technologies aiming at higher collection target (in particular the promotion of informal sector for collection),
- Financing models steering the system towards higher collection; despite the fact no proven relationship between collected amount and financing models have been found and many influencing factors exist, some general observations could be made: in California collectors and recyclers are reimbursed by one of the three agencies involved in managing California's system according to amounts collected and treated.

A similar mechanism is in place in Alberta, Canada. Both State take-back programmes have shown notably an increase in collected amounts in the first two years of activity. In the EU Switzerland has adopted a Recycling Fee model and presents one of the highest collection rates; in Belgium reimbursement for collection by retailers has shown positive effects in growing rates compared to those of municipal collection points,

- Technologies aiming at better environmental performances to be rewarded compared to those having lower environmental performances.

3.7 Conclusion

The analysis of e-waste recycling technologies rated a few technologies to have an innovation potential for developing countries. This includes the pre-processing technologies “manual dismantling/ sorting of fractions”, “de-gassing CFC, HCFC” and “semi-automatic CRT cut and cleaning”, as well as the end-processing technologies integrated smelter for non-ferrous material and aluminium remelter/refiner.

Estimations of generated e-waste volumes for 2020 in selected countries in Asia, Africa and Latin America suggest that all countries would have a potential for the adaptation of pre-processing technologies. Whereas manual dismantling and sorting technologies are already applied in some of the countries, there is no indication that other more advanced technologies are applied. Competition for the adaptation of manual dismantling and sorting technologies originate from a large informal sector in China and India and from a formal sector in South Africa. Because e-waste recycling is only beginning to appear in all other countries, there is a lack of competition for the adaptation of innovative pre-processing technologies.

Due to the large volumes and high investments needed to establish state-of-the-art end-processing facilities, a mid-term medium potential for integrated smelters could only be identified in larger emerging economies such as China, India, South Africa, Brazil and Mexico, whereas aluminium remelter / refiner have a medium to high potential in most countries.

Informal collection and manual dismantling activities do not necessarily need to be transformed to formalized processes and often have advantages over the introduction of new technologies from a sustainability point of view. The informal collection system is rather efficient in countries like India and China because the daily informal collectors are penetrating into each community of the city to collect e-waste from house to house. Moreover, deep-level manual dismantling in formal or informal environments is preferred over semi-automatic processes due to the abundant workforce and low labour costs. However, all other informal activities such as wet-chemical leaching bear great adverse environmental and social impacts and are also often less attractive from an economical point of view than innovative technologies as identified above.

The country analyses indicated that none of the selected countries features an established informal recycling sector while not having an established formal recycling sector at the same time. It is thought that in emerging and large economies like India and China both sectors depend on each other, while it is also known that both sectors in these countries mainly operate in an unsustainable way. The countries could be classified into three groups: Group A is classified as promising for the introduction of pre-processing technologies with a strong support in capacity building (Kenya, Uganda, Senegal, Peru); Group B is classified as

having a significant potential for the introduction of pre- and end-processing technologies with a strong support in capacity building in the informal sector (India, China); Group C is classified as having a significant potential to adapt pre- and to some extent end-processing technologies to their own needs, following a technology and knowledge exchange (South Africa, Morocco, Colombia, Mexico, Brazil).

4 Application of a “Technology Transfer Framework” for selected recycling technologies

4.1 Methodology

This chapter follows the “Framework for Analysis: Technology Transfer to address Climate Change” [101] and aims to formulate the first step of a strategic technology transfer programme for sustainable e-waste recycling technologies in developing countries by:

- Selecting e-waste recycling technologies with the most promise to help create a more sustainable recycling sector. This step is based on the analysis in chapter 3.1 (Innovative e-waste recycling technologies) and summarizes main findings,
- Identifying two possible target countries which would be promising for the introduction of sustainable e-waste recycling technologies, by applying the UNEP technology transfer framework. This step is based on the analysis in chapter 3.4 (Comparative analysis and classification of countries) which is an outcome of chapter 3.2 (E-waste volumes in developing countries) and 3.3 (Market potential of innovative e-waste recycling technologies in selected developing countries),
- Identifying potential barriers and possible interventions (proposed course of action) in support of a successful transfer of sustainable recycling technologies is pivotal. This step is based on the analysis in chapter 3.5 (Identification of barriers for the transfer of sustainable e-waste recycling technologies) and 3.6 (Assessment of mechanisms for technology transfer including financial mechanisms, technical support etc.).

4.2 Sustainable e-waste recycling technologies

E-waste recycling technologies have been described in chapter 3.1 and subsequently rated into (a) innovative technologies for the development of a sustainable recycling sector and (b) technologies not suited to support sustainable recycling in developing countries.

Table 20 summarizes these findings and presents our selection of recycling technologies with the most promise to help create a more sustainable recycling sector in developing countries.

	Waste streams	Economic attributes	Environmental attributes	Social attributes
Manual dismantling/ sorting of fractions	All	Low capital cost, sorting of valuable fractions/ components	Efficient sorting of fractions	Labour intensive, Job creation
De-gassing CFC, HCFC	C&F	Mandatory requirement having low cost	Fundamental step to ensure control over hazardous substances having huge GWP potential	
Semi-automatic CRT cut and cleaning	CRT	Low capital and net cost	Low energy consumption	Labour intensive
Integrated smelter for non-ferrous (pyrometallurgical methods)	Non-ferrous (including printed circuit boards) like Cu, Pb, Zn, Sn or mix	Capital cost high Low net (unit) costs due to economies of scale Local growth potential high	No toxic emissions Low water use Transport: internationally Little waste products Recovery rates >> 90%	Automated process control so less jobs created Highly skilled workforce EHS*
Aluminium remelter/refiner	Aluminium	Capital cost medium –high Net cost low Economies of scale	No toxic emissions Salt slag has to be treated or disposed Env. sound Transport within region or country Water use: low - medium	Job creation: yes Mix of low skilled and high skilled jobs EHS low risks

Table 20: Selection of recycling technologies with the most promise to help create a more sustainable recycling sector in developing countries

4.3 Identification of two target countries for the application of innovation and technologies

Based on our comparative analysis and classification of countries in chapter 3.4, we identified China and South Africa as being promising for the introduction of sustainable e-waste recycling technologies, by applying the UNEP technology transfer framework.

South Africa

Due to the initiative of national producers and importers based on extended producer responsibility (EPR) principles, the support through international development aid programmes (e.g. Swiss e-Waste Programme) and the engagement of the international corporate headquarters of large enterprises (e.g. Hewlett Packard, Dell, Nokia), South Africa is currently implementing a national e-waste recycling compliance scheme, which would ensure that framework conditions will be favourable for a successful technology transfer. In addition the first e-waste recyclers started to become active approximately 16 years ago enabling the country to offer rich experiences for in-depth analysis, which can be transferred to other developing countries. South Africa is a metal mining country, enriching it with a long tradition in technology development in the metallurgy industry. All important stakeholders are part of the current development and the e-waste landscape is well documented, which is the basis to apply a technology transfer framework.

China

The increasing domestic generation and illegal trans-boundary shipment of e-waste have created great challenges to the environment and formal recycling infrastructure. Because the Chinese government is formalizing legislation on e-waste management and seeking an optimal approach to set up formal collection channels and recycling facilities to solve the e-waste problem, it would be meaningful to look into formalizing progress in a country like China with an emerging economy combined with rapid social change.

Directly copying Western pre-processing technology seems not to be working due to the expensive costs and negative social impacts (not much new employment). Instead:

- A cheaper/better recycling technology with less interruption in the current market/labour situation seems to be preferred,
- Formalizing the informal sectors gradually by technology improvement and market intervention can be a way forward,
- Improvement of the existing formal sector and optimization of the interfaces towards the informal sector opens further possibilities,
- As long as for critical e-waste fractions (like PWBs) no local best available technologies (BAT) processes are available, the shipment of such fractions to appropriate end-processing facilities abroad offers both economic and environmental advantages.¹³

Since 2005 a StEP Initiative project entitled “Best of 2 Worlds” has carried out eco-efficiency calculation towards the recycling of ICT equipments in China. The result has shown that deep-level dismantling has lower system cost and higher material revenue, as well as less environmental impact, compared to the scenario of implementing shredding in China. It is both economically and environmentally unfeasible to simply export the shredding technology from developed countries to China. An optimal approach for the e-waste recycling in China is: under strict EHS standards in the recycling facilities, by applying deep manual dismantling to liberate the heterogeneous material and components, critical fractions would enter different channels for professional treatment by applying BAT and other advanced high-tech treatment. This approach can achieve high environmental and economic outcome due to the low labour cost in China and the application of high-tech in the end-processing to ensure high recovery rate of material and low environmental emissions.

¹³ Such shipments to end-processing facilities abroad do not mean that the exporting country (here China) is losing its valuable metals. Usually, refining of PWBs and similar fractions is conducted as a so called “toll refining” business, which means that recovered precious metals and copper can be returned physically to the exporting company. Alternatively, these metals can be sold at current market prices to the refinery.

4.4 Potential barriers and interventions

Chapter 3.5 analyses the barriers for a successful transfer of sustainable e-waste recycling technologies for the selected developing countries. Table 21 intends to summarize this analysis for South Africa (chapter 3.5.1) and China (chapter 0) and group the findings into barriers, which can prevail in a weaker or stronger degree in developing countries in general. In addition the table lists possible interventions that could foster the transfer of a selected technology and innovation in the e-waste recycling sector.

Potential barriers	Interventions to foster the transfer	Countries
Policy and Legislation		
No specific legal framework for e-waste	Policy support, knowledge partnerships, leverage through international treaties (e.g. Basel Convention)	SA, China
Low national priority for e-waste	Awareness raising activities, e.g. through institutionalized intern.l (UN) processes	SA
Conflicting existing legislation	Policy support, harmonization process incl. Integrated Waste Management approaches	SA
Uncoordinated enforcement by different governmental departments and/or alternative levels of government	Policy support, harmonization process	SA, China
Technology and Skills		
Lack of EHS compliance and enforcement	Introducing standards and licensing and auditing process	SA, China
Recycling business is mainly in hands of the informal sector	Alternative business models for informal sector, incentives through better prices	China
Lack of collection infrastructure	Infrastructure development, integration into existing waste collection schemes	SA
Current recycling industry concentrates on “cherry-picking” (generate good revenues and hence are not interested in more sustainable technologies)	Introducing standards and licensing and auditing process	SA, China
Lack of know-how for starting-up a business	Providing info material, “train the trainer”, formation of centres of excellence	SA, China
Lack of awareness for e-waste (as valuable resource and as hazardous waste)	Awareness raising campaign (all levels)	China
Business and Financing		
No or limited producer / distributors responsibility	Lobbying at industry associations, working through international producers, integrating EPR in legal framework	China
High costs for logistics (especially transport and hazardous waste disposal costs)	Introduction of a financing scheme	SA
Exploitation of informal workers in a formalized recycling industry	Introducing standards and licensing and auditing process	SA, China
Crime and recycling industry corruption	Introducing standards and licensing and auditing process	SA, China
Consumer expects to be paid for the broken equipment	Take-back incentive programmes	China

Table 21: Summary of potential barriers to, and possible interventions in support of a successful transfer of sustainable recycling technologies in South Africa (SA) and China

Barriers only affecting the transfer of single recycling technologies have not been identified. To the contrary all barriers as summarized in Table 21 could have a negative effect on the transfer of all technologies as selected in Table 20 in a similar way. This is due to the fact that all technologies demand for a comprehensive framework considering all issues around Policy and Legislation, Technology and Skills, and Business and Financing in order to be sustainable.

4.5 Conclusions

South Africa and China were identified to be promising examples for the application of the UNEP technology transfer framework. South Africa features advanced framework conditions with a strong engagement of the manufacturers and importers industry in e-waste management. China features large volumes and a large interest in e-waste recycling by the informal and the formal sector, which defines a vibrant selection of technology transfer opportunities.

A technology transfer demands for a comprehensive framework considering all issues around Policy and Legislation, Technology and Skills, and Business and Financing in order to be sustainable. Hence potential barriers for the introduction of innovative technologies and intervention mechanisms were identified around these topics. Regarding policy and legislation, the main barriers originate from the lack of specific legal frameworks, low national priority for the topic, conflicting existing legislations and uncoordinated enforcement of the law. Concerning technology and skills barriers are defined primarily through the lack of EHS standards, the strong influence of the informal sector, the lack of collection infrastructure, cherry-picking activities and low skills and awareness. Additional barriers assigned to business and financing topics include limited industry responsibility, high costs of logistics, possible exploitation of workers from disadvantaged communities, crime and corruption and false consumer expectations.

5 Innovation hubs and knowledge centres of excellence in emerging economies

5.1 Methodology

The diffusion of sustainable innovation and technology in emerging economies depends on the interplay among various stakeholders in the areas of science and technology, legislation, market and society. Each group of organizations can play its own exclusive role as innovation hub and serve for different functions in the developing process, while interaction between these stakeholders form a working network towards new and innovative technologies.

E-waste still is a new topic in emerging economies as this waste stream began to become integrated into the recycling industry only a few years ago. Due to this, innovation hubs and centres of excellence have not been established yet. However, a few local organizations exist, which are building up their e-waste competence based on national or international cooperation projects. This includes a few small businesses making early steps in the local development of (low-tech) recycling technologies. In order to get a reasonable analysis of such organizations, this chapter concentrates on the emerging economies of China, India and South Africa, where the development towards innovation hubs and centres of excellence is more advanced than in other countries. The analysis is based on learning experiences from international cooperation projects carried out by Empa, Umicore and UNU in China, India and South Africa and follows the following key elements:

- Identification of organizations with potential to develop into innovation hubs and centres of excellence for e-waste recycling technologies. This step focuses on a selected number of promising organizations with direct or indirect influence for the development of e-waste recycling technologies (namely for the recovery of aluminium, steel, gold, palladium, other strategic metals and materials). Due to scarce literature data this listing cannot be exhaustive, but gives a good insight into the authors on site experience, which is among the largest currently available,
- Analysis of relevant framework conditions and instruments for the development of these organizations and the barriers preventing the replication of technologies that have locally developed. In the case of China, the analysis encompasses the general situation in China based on our project experience. For India the analysis is based on a pilot study with the informal sector in Bangalore. In the case of South Africa the analysis focuses on a pilot project, which - among other national initiatives and pilots - acted as a learning experience for the development of a national e-waste recycling system.

In addition to local national organizations it can be observed that the two multilateral institutions National Cleaner Production Centres (NCPCs) and Basel Convention Regional Centres (BCRCs) were increasingly involved in the e-waste topic and are developing to local and regional knowledge centres. Their current role is discussed in a separate sub-chapter.

5.2 China

5.2.1 Potential innovation hubs and centres of excellence

The following organizations with potential to develop into innovation hubs and centres of excellence were identified from our experience in international cooperation projects with China:

- University and research institutes: Tsinghua University, China Academy of Science, Hong Kong Baptist University, Tongji University, East China University of Science and Technology, Shanghai Jiaotong University, Shantou University, Donghua University,
- Governmental departments: Ministry of Environment Protection/MEP (Department of pollution control); National Development and Reform Commission/NDRC,
- NGOs: Basel Convention Coordinating Center for Asia and the Pacific (Beijing), Greenpeace (Hong Kong).

5.2.2 Analysis of the general situation in China

For the research sector in China, most of the focus has been put on the technology and equipments, which could solve the recycling and detoxification of various types of e-waste. There is a great deal of interest rested on the hydrometallurgical recycling of PWB, which is considered to be low system cost and easy to implement in China considering its economic benefit. However, the limits of this technology with respect to yield and range of metals recoverable and management of toxics are insufficiently addressed so far (see chapter 3.1.2 and table 10). Limited research is concentrating on the toxicology of the hazards from e-waste recycling and the potential policy instrument for e-waste management in China.

In respect to the local government, they have entirely banned any form of e-waste imports into China from 2000, which in praxis does not prevent large inflows of WEEE especially into Southern China. Since 2003, the governments start issuing regulations and standards on environmental and safe operation of e-waste recycling, restricted use of toxins in electrical and electronic equipment, license systems of e-waste recycling etc. The central government has been working on the China WEEE directive since 2005; however it has not yet been finalized at the time when this report is published. In light of these observations, it can be concluded that there is no formal collection system or electronic producer association to manage the e-waste problem in China due to the absence of the key regulations.

Beginning in 2005, four national pilot projects were launched by the Chinese government, which aim to construct large-scale e-waste recycling infrastructures. Therefore, several big formal e-waste recyclers have emerged since then. Despite their fine technologies and treatment facilities, the incapability of collecting sufficient e-waste from the consumers has been bringing much economic burden for these recyclers to sustain daily operation and capital flows.

Thanks to the activities and campaigns done by Basel Action Network (BAN), Greenpeace and others, there is enormous global attention attracted to the e-waste problem in China, especially in regions around Guiyu. There are global initiatives being executed in China in order to ease the tension. For example, the project “Best of 2 Worlds” which is being carried out by UNU/StEP Initiative conducted in cooperation with Chiho-Tiande Metal Co. Ltd aims to seek an eco-efficient recycling approach: The idea is to combine the benefit of deep-level manual dismantling of e-waste in China and local end-processing of less complex (metallic) fractions (Cu, Al, ferrous metals, plastics) with treatment of critical fractions like

circuit boards in state-of-the-art integrated smelters abroad. The Swiss government and Empa have been working closely with the Chinese government to facilitate the development of the national pilot projects.

Comprehensively speaking, the slow process of the political decision and national WEEE directive has a negative effect on the diffusion of a sustainable innovation in China. Without the restriction of the legislation and with the absence of proper subsidies and financial schemes, actions and responsibilities normally taken by the consumers and producers have become suspended, which consequentially prevent the survival and sustainability of current formal recyclers. Stimulation from both the political intervention and market instruments are essential to environmentally close the loop of e-waste recycling in China. More concern and research shall focus on the social and economic impact of various e-waste management scenarios, as well as exploring alternative political instruments and management tools for effective operation of e-waste recycling across China.

5.3 India

5.3.1 Potential innovation hubs and centres of excellence

E-Waste Agency Bangalore (EWA)¹⁴

EWA is an independent organization established by large scale industries, industrial associations, government bodies and NGOs. For the time being the focus of its activities is on Bangalore.

Manufacturers' Association for Information Technology (MAIT)¹⁵

MAIT is representing hardware, training, design/R&D and the associated services sectors of the Indian IT Industry. MAIT actively supported the Indo-German-Swiss Partnership and are coordinating the industry's proposals for the future legal e-waste framework at the national level.

Electronics City Association (ELCIA)¹⁶

ELCIA is the association of the Electronics City located in Southern Bangalore, which is one of India's leading Software Technology Parks (STP). Electronics City currently houses 100 STP units among other institutions. STP units greatly rely upon and use electrical and electronic equipment for their everyday business activities. In order to deal with the increasing amount of e-waste, ELCIA introduced a "Clean e-Waste Channel" (CeWC) which is facilitating convenient and environmentally sound disposal of e-waste for ELCIA member companies in Electronics City.

e-Parisaara¹⁷

e-Parisaara, an eco-friendly recycling unit on the outskirts of Bangalore, makes full use of e-waste. The plant, which is India's first scientific e-waste recycling unit, aims to reduce pollution, landfill waste and recover valuable metals, plastics and glass from waste in an eco-friendly manner.

Electronic and Electrical Waste Recycling, Dismantling and Disposal (e-WaRDD)¹⁸

The recycling company e-WaRDD has approached the Karnataka State Pollution Control Board for Consent of Establishment (CFE) and Consent of Operation (CFO) in December 2007. E-WaRDD is in a phase of transformation from the informal to the formal sector – the

¹⁴ <http://www.ewa.co.in/>

¹⁵ <http://www.mait.com/>

¹⁶ <http://www.elcia.in/>

¹⁷ <http://www.ewasteindia.in/>

¹⁸ <http://india.ewasteguide.info/ewardd>

first of such an event in India. Once formalized, E-WaRDD, as an authorized e-waste recycler, will still maintain good relations with the informal sector, which allows e-WaRDD to collect material from the informal sector. This connection has been one of the struggles for authorized recyclers in getting enough material in competition with the informal sector.

5.3.2 Pilot study informal “wet-chemical leaching” in Bangalore

The analysis is based on a pilot study carried out by the Swiss e-Waste Programme through Empa in the informal sector in Bangalore in partnership with e-WARDD and e-Parisaara as local recyclers (possible innovation hubs, see previous chapter) and Umicore as an international integrated smelter. The aim of the study was to investigate alternative business models (herein interpreted as innovative technology) in order to transfer hazardous operations carried out in the informal sector to state-of-the-art recycling technologies.

The pilot study has shown that besides being hazardous, the wet chemical leaching processes for the recovery of precious metals are also inefficient [77]. Based on these results, "alternative business models" for the informal sector were developed [76], where wet chemical processes are abandoned against international trade with state-of-the-art industries. Based on this conclusion workers in the informal sector would have to change many aspects of their recycling operations. For example, e-waste would not be able to be collected for the conditioning of the recovery of gold only, rather collected with the objective to prepare the optimal fractions for shipment to an integrated smelter (for an overview of possible international state-of-the-art facilities see Table 17). It could be shown that it is possible to create a win-win situation by changing the recycling process. While creating a financial incentive the impact on the environment resulting from improper e-waste recycling could be minimized.

The alternative business model allows e-WARDD to establish itself as an innovation hub, acting as the key player between the informal and the formal sector. The favourable framework conditions to allow for initiating e-WARDD were predominately given by the network and intensive capacity building of the Swiss e-Waste Programme and strong local leadership by individuals. The biggest barrier for the implementation of the alternative business model was the typical five-month delay between the shipment and the payment by an integrated smelter, which poses some serious cash flow problems for the recyclers, as the informal sector usually works on a day-to-day basis. Possible solutions to this problem include a buffer model, where a potent, larger formal recycler (local or international) or an organization acts as an intermediate between the smaller semi-informal recyclers and the integrated smelter. In any case the successful implementation of the pilot alternate business model was found to be a “condicio sine qua non” for allowing the maximum, but safe participation of the informal sector to the Clean e-Waste Channels. We see this as an opportunity for the formal recyclers to get access to higher e-waste volumes and for the informal sector to still create their income in a safe way.

5.4 South Africa

5.4.1 Potential innovation hubs and centres of excellence

Information Technology Association (ITA)¹⁹ and e-Waste Association of South Africa (eWASA)²⁰

The ITA represents various companies concerned with the supply of information technology equipment, systems, software and services in the ICT industry. The ITA is the main industry partner in the Swiss e-Waste Programme and as part of the programme in developing a national e-waste recycling scheme for South Africa. For this purpose the ITA founded the e-Waste Association of South Africa in 2008 (eWASA).

E-waste recyclers

South Africa already saw the first formal e-waste recycler in 1992 (Desco). Since then many new ones appeared, especially within the last two years which is partially a result of increased awareness raising through the ITA/eWASA and the Swiss e-Waste Programme. The current list of recyclers is available at <http://www.ewasa.org/recyclers>. The development and the operations of Recover e Alliance was monitored and analysed by an international cooperation project and university students. This recycler, as a potential innovation hub is discussed in detail in the next chapter.

5.4.2 Pilot project formalized “Material Recovery Facility” in Cape Town

For the analysis we chose the Material Recovery Facility (MRF) in Maitland, Cape Town, which was started as a pilot project by the Recover e Alliance (possible innovation hub) in early 2008, as part of the HP / DSF / Empa project “e-Waste Management in Africa”.

First, small-scale e-waste collection and dismantling activities in Cape Town were already initiated in 2004 by various NGOs and private individuals and have been supported since then by the “Global Knowledge Partnerships in e-Waste Recycling” programme, which was initiated by the Swiss State Secretariat of Economics Affairs (SECO) and has been implemented by Empa in South Africa, India and China²¹. It became evident that the demand for such services far exceeded the operational capacities of these small-scale activities. The need for a regional medium-scale dismantling facility was therefore identified, in order to be able to process larger volumes and a wider range of e-waste materials.

The pilot project in Maitland was initiated with the aim to:

- Test the feasibility of an integrated value adding local e-waste management system, designed to maximize the potential of refurbishment, repair, reuse, dismantling and recycling of equipment, with environmentally responsible disposal only as a last resort,
- Act as a nucleus, raising awareness, and providing training and education to previously disadvantaged individuals as a means of creating opportunities for entrepreneurship in the technical maintenance, dismantling and waste-to-art project sectors,
- Serve as a replicable concept for other initiatives in developing countries.

The MRF is divided into three distinctive working areas, namely i) testing/refurbishing, ii) dismantling and iii) waste to art (W2A) production sections. The project was continuously

¹⁹ <http://www.ita.org.za/>

²⁰ <http://www.ewasa.org>

²¹ <http://ewasteguide.info>

evaluated. A SWOT analysis was performed in late 2008. The outcome can be summarized as follows:

The favourable framework conditions under which this pilot project developed include: existing large stakeholder network (national and international) and advanced consumer awareness due to the joint initiatives between the ITA/eWASA and the Swiss e-Waste Programme, international funding (Hewlett Packard), local government as a strong supporter of the pilot, strong local leadership and dedication through individuals and low labour costs. The main barriers hampering the pilot in a smoother and larger development include: lack of clear guidance from the national government regarding legal compliance of such (partly hazardous) operations, strong competition operating on a lower social and environmental responsible level limiting the access to material, sometimes poor quality of equipment lowering the intrinsic value and some safety issues. In addition a clear sustainable solution, considering downstream processes (e.g. disposal of hazardous fractions), largely depends on the available local infrastructure.

However, the pilot revealed many opportunities. Operations with a high ethical standard attract corporate users, which are interested in e.g. making use of the project as part of their corporate social responsibility projects (refurbish and donate, sustainable recycling, corporate gifts from the Waste to Art section etc.). Since such operations involve little investments and overheads, they represent a decentralized approach of pre-processing technologies and hence are scalable in size, geographically more flexible and replicable and are easily implemented in / transferred to other developing countries.

5.5 Multi-lateral institutions

5.5.1 National Cleaner Production Centres (NCPCs)

Most NCPCs were initiated by the United Nations Development Organization (UNIDO) or through bilateral agreements between donor and recipient countries. NCPCs aim at building cleaner production capacities, fostering dialogue between industry and government and enhancing investments for transfer and development of environmentally sound technologies. These programmes are bridging the gap between competitive industrial production and environmental concerns. UNIDO started in 1994, to set up NCPCs and since then, nearly 43 National Cleaner Production Centres and Programmes have been established. For the next phase of further developing NCPCs UNIDO has set e-waste as one of the main topics.

NCPCs were involved in e-waste research and implementation activities in Colombia [62], Morocco [59] and Uganda [98] and are currently topic leaders in their country. It is thought that NCPCs provide an excellent stakeholder network and a potential to expand their knowledge into recycling and sustainability issues for research studies, implementation and organization.

5.5.2 Basel Convention Regional Centres (BCRCs)

The Basel Convention on the Control of Transboundary Movements of Hazardous Wastes and their Disposal is a global environmental treaty on hazardous and other wastes. The Convention has 170 members (Parties) and aims to protect human health and the environment against the adverse effects resulting from the generation, management, transboundary movements and disposal of hazardous and other wastes. The Basel

Convention benefits from a network of fourteen Regional and Coordinating Centres for Capacity Building and Technology Transfer (BCRCs). The centres operate under the authority of the Conference of the Parties, the decision-making organ of the Convention, composed of all the countries party to the Convention. The BCRCs are established under two types of agreement: by being hosted in an inter-governmental institution or by vesting a national institution with a regional role to support countries within a region in their implementation of the Convention.

At the sixth meeting of the Conference of the Parties (COP6) in 2003 the Mobile Phone Partnership Initiative (MPPI) was established as a sustainable partnership on the environmentally sound management of used and end-of-life mobile telephones. E-waste was declared a major topic in the eighth meeting (COP8) in the so called Nairobi declaration in 2006. The Partnership for Action on Computing Equipment (PACE) was launched at the ninth meeting (COP9), which took place in Bali in 2008. PACE is a multi-stakeholder partnership that will provide a forum for governments, industry leaders, non-governmental organisations and academia to tackle the environmentally sound management, refurbishment, recycling and disposal of used and end-of-life computing equipment.

BCRCs, under the coordination of the Secretariat of the Basel Convention, have performed e-waste related projects in Asian countries since 2005. In this context, national inventories of e-waste have been undertaken, management plans prepared, regional guidelines for inventory and ESM developed. Similar studies have been started in Africa and Latin America and the Caribbean. There is also a plan to collect and disseminate information on ESM techniques and technologies.

Similar to the NCPCs, BCRCs provide an excellent stakeholder network and a potential to act as a knowledge hub with a focus on policy issues and control mechanisms, as well as technological and scientific issues associated with hazardous waste.

5.6 Conclusions

Due to the early stage of awareness for e-waste recycling in emerging economies, innovation hubs and centres of excellence have not been established yet. However, some organizations are currently establishing their e-waste competence and have a great potential to develop into innovation hubs. Multilateral institutions, mainly National Cleaner Production Centres and Basel Convention Regional Centres develop into knowledge hubs for e-waste management in some countries. The current situation in China, India and South Africa indicate that smaller and less complex economies such as South Africa's improve faster in awareness and competence.

Crucial instruments and framework conditions for the development of innovation hubs include the possibility to participate in international knowledge partnerships programmes. It also has been observed that without clear legal framework and active participation of the government, the development of innovative technologies is hampered. The future success of technological innovation in environments with strong informal participation strongly depends on alternative business models with financial incentives, which allow the informal sector to still participate with "safe" recycling processes, while hazardous operations are transferred to state-of-the-art formal recyclers. The development of innovation hubs also demand for a fair competitive environment with common rules, clearly favouring the development and application of innovative technologies.

6 References

- [1] Hagelüken, C. and C.E.M. Meskers. *Mining our computers- opportunities and challenges to recover scarce and valuable metals from End-of-Life electronic devices*. In: H. Reichl, N.F. Nissen, J. Müller and O. Deubzer (eds): *Electronics Goes Green 2008+*. Stuttgart: Fraunhofer IRB Verlag, 2008, pp. 623-628.
- [2] Gartner. Inc. *Gartner says worldwide mobile phone sales increased 16 per cent in 2007*. Press release 27 February 2007.
- [3] Swiss Center for Life Cycle Inventories. *EcoInvent Data v2.0. 2006*.
- [4] European Union. *Directive 2002/95/EC on the restriction of the use of certain hazardous substances in electrical and electronic equipment*. Brussels, 2003.
- [5] Puckett, J. et al. *Exporting harm*. Seattle: Basel Action Network, 2002.
- [6] Puckett, J. et al. *The digital dump*. Seattle: Basel Action Network, 2005.
- [7] Bridgen, K. et al. *Chemical contamination at e-waste recycling and disposal sites in Accra and Korforidua, Ghana*. Amsterdam: Greenpeace, 2008.
- [8] Kuper, J. and M. Hojsik. *Poisoning the poor: electronic waste in Ghana*. Amsterdam: Greenpeace, 2008.
- [9] *US Geological Survey. Minerals Commodities Summary 2007*. Washington, 2007.
- [10] GFMS. *Platinum and palladium survey 2007*. London, 2007.
- [11] Johnson Matthey. *Platinum 2008*. London, 2008.
- [12] Chancerel, P. C.E.M. Meskers, C. Hagelüken and S. Rotter. *Assessment of metal flows during pre-treatment of waste electrical and electronic equipment focusing on precious metals*. Submitted to *Journal of Industrial Ecology*, 2008.
- [13] Hagelüken, C. *Improving metal returns and eco-efficiency in electronics recycling*. In: *Proceedings of the 2006 IEEE Int. Symposium on Electronics and the Environment*. IEEE, 2006, pp. 218-223.
- [14] Reuter, M.A. and A. van Schaik. *Thermodynamic metrics for measuring the 'sustainability' of Design for Recycling*. In: *JOM*, Vol. 60, No. 8 August 2008, pp. 39-46.
- [15] Reuter M.A., U.M.J. Boin, A. van Schaik, E. Verhoef, K. Heiskanen, Y. Yang, G. Georgalli. *The metrics of material and metal ecology*. Amsterdam: Elsevier, 2005.
- [16] EAA/OEA Recycling Division. *Aluminium recycling – the road to high quality products*. Brussels, 2004. Via: www.eaa.net
- [17] The Global Aluminium Recycling Committee. *Global aluminium recycling: a cornerstone of sustainable development*. London: International Aluminium Institute, 2006.
- [18] Huisman J. et al. *2008 Review of Directive 2002/96 on Waste Electrical and Electronic Equipment (WEEE)*. Bonn: United Nations University, 2007.
- [19] NOKIA. *Global consumer survey reveals that majority of old mobile phones are lying in drawers at home and not being recycled*. Press release July 2008.
- [20] Sepúlveda, A., M. Schluep, et al. *A review of environmental fate and effects of hazardous substances released from electrical and electronic equipments during recycling: examples from China and India*. Submitted to *Environmental Impact Assessment Review*.
- [21] Kang, H.-Y. and J.M. Schoenung. *Electronic waste recycling: A review of U.S. infrastructure and technology options*. In: *Resources, Conservation and Recycling*, 2005. 45, pp. 368-400.

- [22] Darby, L. and L. Obara. *Household recycling behaviour and attitudes towards the disposal of small electrical and electronic equipment*. In: Resources Conservation And Recycling, 2005. 44(1), pp. 17-35.
- [23] Clodic D. and F. Sauer. *Recupero dei clorofluorocarburi e degli altri fluidi frigorigeni*. Masson, 1995.
- [24] Scottish Environmental Protection Agency. *Guidance on the Recovery and Disposal of Controlled Substances Contained in Refrigerators and Freezers*. Bristol, 2002.
- [25] Biffa Waste Service. WEEE REMarket. Exter, 2002.
- [26] Luga A., R. Morar, A. Samuila, L. Dascalescu. *Electrostatic separation of metals and plastic from granular industrial wastes*. I IEE Proc. Sci. Meas. Technol., Vol 148, No. 2, March 2001.
- [27] Miyake A, PWMI Japan, (Sumito Chemichal Co. Ltd), IDENTIPLAST 1997.
- [28] Murase A., PWMI Japan, (Toyota Central RandD), IDENTIPLAST 1997.
- [29] Amano T., Opt Research Inc., IDENTIPLAST 1997.
- [30] Seidel T., AGR, IDENTIPLAST 1997.
- [31] Zumbühl, D., *Mass flow assessment (MFA) and assessment of recycling strategies for cathode ray tubes (CRTs) for the Cape Metropolian Area (CMA), South Africa*. Zürich / St. Gallen: ETH Zurich / Empa, 2006.
- [32] Aanstoos T. et al. *Disassembly Process for a Cathode Ray Tube*. The University of Texas at Austin, 1997.
- [33] ICER. *New approach to CRT recycling*. A Report prepared for DTI, August 2003.
- [34] Demanufacturing of Electronic Equipment for Reuse and Recycling (DEER2) Technology and Demonstration Center. *Final CDRL C006 Information Report Subtask GL-06b Glass Cleaning*. December 2002.
- [35] Goldenberg et al. *Development of Advanced CRT disassembly technology*. IEEE 2002.
- [36] Hagelüken, C. *Recycling of electronic scrap at Umicore's integrated metals smelter and refinery*. In: Erzmetall, 2006, 59, pp. 152-161.
- [37] Cui J. and L. Zhang. *Metallurgical recovery of metals from electronic waste: A review*. Journal of hazardous materials, Vol. 158, 2008, pp 288-256.
- [38] EAA/OEA Recycling Division. *Aluminium Recycling the road to high quality products*. Brussels, 2006.
- [39] Boin U.M.J. and M. Bertram: *Melting standardize aluminium scrap: a mass balance model for Europe*. In: JOM, No 8 2005, pp 26–33.
- [40] Reuter, M.A., U.M.J. Boin, A. van Schaik, E. Verhoef, K. Heiskanen, Y. Yang and G. Georgalli. *The Metrics of Material and Metal Ecology*. In: Developments, Vol 16, 2005.
- [41] *Aluminiumrecycling – vom Vorstoff bis zur fertigen Legierung (Aluminium recycling – the route from raw material to the finished alloy)*. Edited by K. Krone, 2002. Published by VAR Verband de Aluminiumrecycling-Industrie.
- [42] Xiao Y., M.A. Reuter, U. Boin. *Aluminium recycling and environmental issues of salt slag treatment*. In: Journal of Environmental Science and Health, Vol 40, No 10, 2005, pp 1861 – 1875.
- [43] The global aluminium recycling committee: *Global aluminium recycling: a cornerstone of sustainable development*, 2006. London: International Aluminium Institute.
- [44] Boerrigter, H. *Implementation of Thermal Processes for Feedstock Recycling of Bromine, with Energy Recovery, from Plastic Waste of Electrical and Electronic Equipment (WEEE) – Phase 2: Production of Bromine Salt in Staged-gasification to Determine Technical Feasibility of Bromine Recovery*. ECN-C-01-110 Report (Final version), 2001.

- [45] Boerrigter, H. *Implementation of Thermal Processes for Feedstock Recycling of Bromine, with Energy Recovery, from Plastic Waste of Electrical and Electronic Equipment (WEEE) – Phase 1: Literature survey/status update, evaluation, and ranking of combustion, gasification, and pyrolysis based technologies*. ECN-C-01-110 Report, 2000.
- [46] Boerrigter, H. *Implementation Of Thermal Processes For Feedstock Recycling Of Bromine And Antimony, With Energy Recovery, From Plastics Waste Of Electrical And Electronic Equipment (WEEE), Phase 1. Unit*. ECN Biomass of the Netherlands Energy Research Foundation (ECN), 2000.
- [47] Tukker, A., H. de Groot et al. *Chemical Recycling of Plastics Waste (PVC and other resins)*. TNO Report. TNO Institute of Strategy, Technology and Policy for European Commission, DG III. The Netherlands, 1999.
- [48] Fisher, M. et al. (APC APME). *Energy Recovery in the Sustainable Recycling of Plastics from End-of-Life Electrical and Electronic Products*. Prepared for: 2005 IEEE International Symposium on Electronics and the Environment (2005 ISEE/SUMMIT), 16-19 May 2005, New Orleans, LA USA.
- [49] Delavelle, C., D. Fayolle (AJI-EUROPE) and R. Eyssen (Japan Consult). *Characterisation des Plastiques Contenus dans les DEEE et Etat des Lieux de la Valorisation de ces Plastiques - Rapport final*. ADEME, 2005.
- [50] Mark, F.E. (Dow Chemical Europe). *The characteristics of plastics-rich waste streams from end-of-life electrical and electronic equipment*. 2006.
- [51] Mark, F.E., H. Dresch et al. *Large scale demonstration of the treatment of electrical and electronic shredder residue - by co-incineration in the Würzburg Municipal Solid Waste Incinerator*. Brussels: A Technical Report by PlasticsEurope, 2006. Via: www.isopa.org/htdocs/isopa_site/documents_ns/TECHNICAL%20REPORT.pdf
- [52] Mark, F.E. *Polyurethane Energy Recovery and Feedstock Recycling Technology. A Summary Overview of Latest European Technologies*. Paper given at the API (Alliance for the Polyurethanes Industry) Conference in October 2005. Via: www.isopa.org/htdocs/isopa_site/documents_ns/api2005.pdf
- [53] Finlay, A. and D. Liechti. *e-Waste Assessment South Africa*. Johannesburg: E-Waste Association of South Africa (<http://www.ewasa.org>), 2008.
- [54] Widmer, R. and R. Lombard. *e-Waste Assessment in South Africa, a case study of the Gauteng province*. 2005.
- [55] Waema, T. and M. Muriethi. *e-Waste Management in Kenya*. 2008.
- [56] Berry, T. and H. Knowles. *Emerging Responsibilities, managing environmental impacts of end-of-life mobile phones in developing countries*. 2007.
- [57] Kinyanjui, K. *Computer Sales to double in three years*. Business Daily. 10 September 2008. Via: http://www.bdafrica.com/index.php?option=com_contentandtask=viewandid=9925andItemid=5847.
- [58] Schlupe, M et al. *e-Waste generation and management in Uganda*. 2008.
- [59] Laissaoui, S.E. and D. Rochat. *Technical report on the assessment of e-waste management in Morocco*. Moroccan Cleaner Production Centre and Empa, HP/DSF/Empa project “e-Waste Management in Africa”, 2008.
- [60] Wone, S.S. and D. Rochat. *Rapport technique de l'état des lieux de la gestion des e-déchets au Sénégal*. Dakar : Sénéclic and Empa, 2008.
- [61] Espinoza, O., et al. *Diagnóstico del Manejo de los Residuos Electrónicos en el Perú*. Lima: IPES and Empa, 2008.

- [62] Ott, D. *Gestion de Residuos Electrónicos en Colombia. Diagnóstico de Computadores y Teléfonos Celulares*. Medellín: Empa, 2008.
- [63] Román Moguel, G.J. *Diagnóstico sobre la Generación de Basura Electrónica en México*. 2007.
- [64] The Canadian Trade Commissioner Service. *Mexico ICT Market Overview. Trends and Opportunities*. 2007.
- [65] MAIT. *IT Industry Performance. Mid-Year Review 2007-2008*. 2008.
- [66] eTechnology Group@IMRB. *e-Waste Assessment in India. A Quantitative Understanding of Generation, Disposal and Recycling of Electronic Waste in India*. 2007.
- [67] Cobbing, M. *Toxic Tech: Not in our Backyard*. Greenpeace Report. 2008.
- [68] Liu, X. et al. *Electrical and electronic waste management in China: progress and the barriers to overcome*. In: *Journal of Waste Management Resources*, Vol 24, 2006, pp. 92 - 101.
- [69] Li, J. et al. *Status quo of e-waste management in mainland China*. *Journal of Material Cycles and Waste Management*, Vol 8. 2006, pp. 13 – 20.
- [70] Zhang, B. *China TV Market Trends by Technology*. 2006
- [71] People Daily Online. *China PC sales value growth tempered by price war*. February 27, 2008. Via: <http://english.people.com.cn/90001/90781/6361488.html>
- [72] People Daily Online. *China's mobile phone users reach 592 mln by end of May*. June 26, 2008. Via: <http://english.people.com.cn/90001/90776/90882/6437013.html>.
- [73] People Daily Online. *China mobile phone sales volume drops 0.3% in 2007*. December 26, 2008 Via: <http://english.people.com.cn/90001/90776/6327985.html>.
- [74] CRIENGLISH.com. *Mobile Phone Subscribers Top 383 mln*. November 23, 2005. Via: <http://english.cri.cn/855/2005/11/23/262@32391.htm>.
- [75] Streicher-Porte, M. *Material Flow Analysis and economic evaluation as tools for system design in recycling of waste from electrical and electronic equipment. Special focus on the recycling of personal computers*. Dissertation: ETH No. 16957. SWISS FEDERAL INSTITUTE OF TECHNOLOGY ZURICH. 2006.
- [76] Rochat, D., W. Rodrigues, and A. Gantenbein. *India: Including the Existing Informal Sector in a Clean e-Waste Channel*. In: *Proceedings of the Waste Management Conference (WasteCon2008)*, 2008.
- [77] Keller, M., *Assessment of gold recovery processes in Bangalore, India and evaluation of an alternative recycling path for printed wiring boards*, Master Thesis ETH and Empa, Zurich and St.Gallen/ Switzerland. pp. 105. 2006.
- [78] Habashi, F. *Handbook of extractive metallurgy*. Vol 1-4. Weinheim: Wiley-VHC, 1997.
- [79] Rosenquist, T. *Principles of extractive metallurgy*, Tapir Verlag, 2004.
- [80] *Ullmann's Encyclopedia of industrial chemistry*.
- [81] www.isasmelt.com
- [82] Nnorom, I.C. and O. Osibanjo. *Sound management of brominated flame retarded (BFR) plastics from electronic wastes: State of the art and options in Nigeria*. In: *Resources, Conservation, Recycling*, Vol 52, No 12, 2008, pp. 1362- 1372.
- [83] Gregory, J. and R. Kirchain. *Eco-efficient recycling alternatives for End-of-Life cathode ray tubes*. In: *Proceedings of the EPD Congress 2006*, S.M. Howard et al. (eds.), TMS, Warrendale USA, 2006, pp. 909 – 918.
- [84] Kulkarni, P.S., J.G. Crespo, and C.A.M. Alfonso. *Dioxins sources and current remediation techniques – A review*. In: *Environment International*, Vol 34, No 1, 2008, pp. 139-153.

- [85] McKay, G. *Dioxin characterization, formation and minimization during municipal solid waste (MSW) incineration: review*. In: Chemical Engineering Journal, Vol 86, No 3, 2002, pp. 343-368.
- [86] Lehner, T. *Integrated recycling of non-ferrous metals at Boliden Ltd. Ronnskar smelter*. In: Proceedings of the IEEE International Symposium on Electronics and the Environment, 1998, pp. 42-47.
- [87] Veldhuizen, H. and B. Sippel. *Mining discarded electronics*. In: Industry and Environment, Vol 17, No 3 , 1994.
- [88] Li, J., H. Lu, J. Guo, Z. Xu, And Y. Zhou. *Recycle technology for recovering resources and products from waste printed circuit boards*. In: Environmental Science and Technology, Vol 41, No 6, 2007, pp. 1995-2000.
- [89] Sheng, P.P. and T.H. Etsell. *Recovery of gold from computer circuit board scrap using aqua regia*. In: Waste management and research, Vol 25, 2007, pp. 380-383.
- [90] Lee, J., H.T. Song, J.-M. Yoo. *Present status of the recycling of waste electrical and electronic equipment in Korea*. In: Resources Conservation and Recycling, Vol 50, No 4, 2007, pp. 380-397.
- [91] Veglio, F., R. Quaresima, P. Fornari, And S. Ubaldini. *Recovery of valuable metals from electronic and galvanic industrial wastes by leaching and electrowinning*. In: Waste Management, Vol 23, 2003, pp. 245-252.
- [92] Veit, H.M et al. *Recovery of copper from printed circuit board scraps by mechanical processing and electrometallurgy*. In: Journal of Hazardous Materials, Vol B137, 2006, pp. 1704-1709.
- [93] Oishi, T., K. Koyama, S. Alam, M. Tanaka. And J.-C. Lee. *Recovery of high purity copper cathode from printed circuit boards using ammoniacal sulfate or chloride solutions*. In: Hydrometallurgy, Vol 89, 2007, pp 82-88.
- [94] Hilson, G. And A.J. Monhemius. *Alternatives to cyanide in the gold mining industry: what prospects for the future?* In: Journal of Cleaner production, Vol 14, 2006, pp 1158-1167.
- [95] Dittke, M.. *A review of South African environmental and general legislation governing e-waste*. e-Waste Association of South Africa, 2007.
- [96] Waema, T. and M. Muriethi. *E-waste Management in Kenya. Kenyan ICT Action Network (KICTANet), HP/DSF/Empa project “e-Waste Management in Africa”, 2008*.
- [97] Basyie, K.K., *Extended Producer Responsibility for the Management of Waste from Mobile Phone*. Master Thesis Lund University Sweden, 2008.
- [98] Wasswa, J. and M. Schluep. *e-Waste Assessment in Uganda*. Kampala: Uganda Cleaner Production Centre and Empa, 2008.
- [99] Marthaler, C., *Computers for schools: sustainability assessment of supply strategies in developing countries, a case study in Colombia*. Master Thesis ETH Zurich and Empa St.Gallen, 2008.
- [100] Gonzalez, R., *Integrated Electronic Waste Management in Mexico: Law, Technology and Public Policy*. Master Thesis MIT Boston /USA, 2004.
- [101] Metz B., O.R. Davidson et al. *Methodological and Technological issues in Technology Transfer, IPCC special reports on climate change*, UNEP/Grid Arendal, Cambridge University Press; 1. Edition July 10, 2000.
- [102] Kuehr, R. and E. Williams. *Computers and the Environment: Understanding and Managing their Impacts*. Kluwer/Springer, 2004.
- [103] Consumer Electronics Association. *US Consumer Electronics Sales and Forecast, 2003-2008*, 2008.
- [104] *E-Waste Toxic Link Fact Sheet, Number 31*, November 2007.

- [105] W. He et al. *WEEE recovery strategies and the WEEE treatment status in China*. In: Journal of Hazardous Materials B136, 2006, 502–512.
- [106] GSM Association. *Mobile Phone Lifecycles, Use, Take-back, Reuse and Recycle report*.
- [107] Cui et al. *Mechanical recycling of waste electric and electronic equipment: a review*. Journal of Hazardous Materials, B99, 2003, pp. 243–263.
- [108] Ropohl, G. *Technologische Aufklärung: Beiträge zur Technikphilosophie*. Frankfurt/Main, 1991.
- [109] Hammann, P. and H. Mittag. *The marketing of Industrial Technology Through Licensing*. In: Backhaus, Klaus and David T. Wilson (eds.), Industrial marketing, Berlin, 1986, pp. 224-242.
- [110] Kuehr, R., *Environmental technologies – from misleading interpretations to an operational categorisation and definition*. In: Journal of Cleaner Production, Vol 15, 2007, pp. 1316-1320.
- [111] Hillebrand, W. et al. *Strengthening Technological Capability in Developing Countries - Lessons from German Technical Cooperation*, Berlin 1994.
- [112] Wang, F. et al. *Economic conditions for formal and informal recycling of e-waste in China*. In: H. Reichl, N.F. Nissen, J. Müller and O. Deubzer (eds): Electronics Goes Green 2008+. Stuttgart: Fraunhofer IRB Verlag, 2008, pp.845-850.
- [113] Magalini, F., J. Huisman. *Management of WEEE & Cost Models across EU: Could the EPR principle lead US to a better Environmental Policy?* IEEE International Symposium on Electronics and the Environment, May 2008.
- [114] M.D. Felton. *Mineral Commodity Summaries: Steel*. US Geological Survey: January 2008.
- [115] World Steel Association. Via: www.worldsteel.org
- [116] *World Steel in figures 2008, 2nd edition*. World Steel Association, Brussels 2008.
- [117] Sims Recycling Solutions. Via: http://www.sims-group.com/srs/solutions/en crt-treatment_sc.asp

About the StEP Initiative

StEP was founded to offer an impartial global platform for developing sustainable solutions for e-waste management. We work to reduce environmental risks and increase resource recovery worldwide.

StEP engages with all aspects of e-waste management, bringing together political, social, economic and environmental issues through collaboration. Stakeholders and project partners range from multi-national companies to academic and research centres. Our name is our programme.

StEP's prime objectives are:

- > To act as a knowledge hub on e-waste for industrialized and industrializing countries
- > To increase re-use of electrical and electronic equipment
- > To increase materials recovery from e-waste
- > To support the safe processing of e-waste
- > To encourage life cycle thinking
- > To develop clear policy recommendations

As a science-based initiative founded by various UN organizations we create and foster partnerships between companies, governmental and non-governmental organizations and academic institutions.

Members and Associate Members of the StEP Initiative are:

International Organizations:

Center for Environment and Development for the Arab Region and Europe (CEDARE), Global Digital Solidarity Fund (DSF), United Nations Conference on Trade and Development (UNCTAD), United Nations Environment Programme (UNEP), United Nations Industrial Development Organization (UNIDO), United Nations University (UNU)

Governmental and Development Cooperation:

German Technical Cooperation (GTZ), Swiss State Secretariat of Economics (SECO), US Environmental Protection Agency (US-EPA)

Business & Industry:

AER Worldwide, Cisco Systems Ltd., Compliance & Risks, Dataserv Ltd., Datec Technologies, Dell, Ericsson, Flection, GOAB mbH, Hewlett Packard, MicroPro, Microsoft, Nokia, Philips CL, promotion team wetzlar, Sims Recycling Solutions, Taizhou Chiho Tiande, UMICORE Precious Metal Refining, Wellington Green

Academia & Research:

Austrian Society for Systems Engineering and Automation (SAT), Bio Intelligence Service (biois), Chinese Academy of Sciences – Research Center for Environmental Sciences, Delft University of Technology, ENDA-Europe*, Federal Laboratories for Materials Testing and Research (EMPA), GAIKER Foundation, Griffith University, Institute for Applied Ecology (Öko-Institut), Fraunhofer Institute for Reliability and Microintegration (FHG-IZM), Korean Institute of Geoscience and Mineral Resources (KIGAM), Massachusetts Institute of Technology (MIT) – Materials Systems Laboratory, National Center for Electronics Recycling (NCER), Regional Environmental Center for Central and Eastern Europe (REC), Rifer Environmental, Technische Universität Braunschweig – Institute of Machine Tools and Production, TELECOM & Management Sud Paris, Electrical and Electronic Institute (EEI), University of Limerick, University of Melbourne – Faculty of Engineering, 3P Consortium for Sustainable Management, WASTE advisers on urban environment and development*

* Associate Member

For more information, see
www.step-initiative.org

About the UNEP Division of Technology, Industry and Economics

The UNEP Division of Technology, Industry and Economics (DTIE) helps governments, local authorities and decision-makers in business and industry to develop and implement policies and practices focusing on sustainable development.

The Division works to promote:

- > sustainable consumption and production,
- > the efficient use of renewable energy,
- > adequate management of chemicals,
- > the integration of environmental costs in development policies.

The Office of the Director, located in Paris, coordinates activities through:

- > **The International Environmental Technology Centre** - IETC (Osaka, Shiga), which implements integrated waste, water and disaster management programmes, focusing in particular on Asia.
- > **Sustainable Consumption and Production** (Paris), which promotes sustainable consumption and production patterns as a contribution to human development through global markets.
- > **Chemicals** (Geneva), which catalyzes global actions to bring about the sound management of chemicals and the improvement of chemical safety worldwide.
- > **Energy** (Paris), which fosters energy and transport policies for sustainable development and encourages investment in renewable energy and energy efficiency.
- > **OzonAction** (Paris), which supports the phase-out of ozone depleting substances in developing countries and countries with economies in transition to ensure implementation of the Montreal Protocol.
- > **Economics and Trade** (Geneva), which helps countries to integrate environmental considerations into economic and trade policies, and works with the finance sector to incorporate sustainable development policies.

*UNEP DTIE activities focus on raising awareness,
improving the transfer of knowledge and information,
fostering technological cooperation and partnerships, and
implementing international conventions and agreements.*

For more information, see
www.unep.fr

For more information, contact:

**UNEP DTIE
Sustainable Consumption and
Production Branch**

15 rue de Milan
75441 Paris CEDEX 09
France
Tel: +33 1 4437 1450
Fax: +33 1 4437 1474
E-mail: unep.tie@unep.org
www.unep.fr

StEP Initiative

c/o UNITED NATIONS UNIVERSITY
Hermann-Ehlers-Str. 10
53113 Bonn
Germany
Tel.: +49-228-815-0214/3
Fax: +49-228-815-0299
Email: info@step-initiative.org
www.step-initiative.org

www.unep.org

United Nations Environment Programme
P.O. Box 30552 Nairobi, Kenya
Tel.: ++254-(0)20-62 1234
Fax: ++254-(0)20-62 3927
E-mail: cpiinfo@unep.org



The appropriate handling of electronic waste (e-waste) can both prevent serious environmental damage but also recover valuable materials, especially different types of metals such as aluminium, copper, palladium and gold. This publication focuses on the significance and possibilities of getting resources back out of e-waste through a sustainable technology transfer in the field of recycling. It provides an analysis of the transfer potential of relevant technologies in the recycling sector in selected developing countries. Hazardous elements present in e-waste are duly considered, and their proper handling and treatment is addressed to prevent environmental or health impacts.



Materials Science & Technology



UNITED NATIONS
UNIVERSITY

DTI/1192/PA